

Installationsplan / Installation plan

Installatietekening
Plan d'installation
Pianta di installazione

Plano de instalación
Plano de instalação
Σχέδιο εγκατάστασης

Asennusohje
Installasjonsplan
Installationsplan

PG 8056



Materialnummer	/	Mat. no.	10595150
Änderungsstand	/	Version	00
Änderungsnr.	/	Alteration number	A43503
Datum Zeichnung	/	Drawing Date	01.10.2015
Datum Legende	/	Legend Date	23.09.2016

Technisches Datenblatt



Gewerbegeschirrspüler

PG 8056

Legende:







Fett eingekreiste Kurzzeichen bedeuten:
Anschluss erforderlich

DE



Strichpunktiert eingekreiste Kurzzeichen bedeuten:
Anschluss optional oder nach Geräteausführung erforderlich

EL	Elektroanschluss	1. Spannung (Lieferzustand) Anschlusswert Absicherung Anschlusskabel, Querschnitt mindestens Länge Anschlusskabel (H05(07)RN-F) mit CEE-Stecker		V/Hz kW A mm ² m	3N AC 400/50 8,9 3 × 16 5 × 2,5 ca. 1,7
		Spannung Anschlusswert Absicherung Anschlusskabel, Querschnitt mindestens Länge Anschlusskabel (H05(07)RN-F) mit Stecker	umbaubar	V/Hz kW A mm ² m	AC 230/50 3,4 16 3 × 1,5 ca. 2,1
Hiervon abweichend in folgenden Ländern:					
B N		2. Spannung (Lieferzustand) Anschlusswert Absicherung Anschlusskabel, Querschnitt mindestens Länge Anschlusskabel (H05(07)RN-F) ohne Stecker		V/Hz kW A mm ² m	3 AC 230/50 7,1 3 × 20 4 × 2,5 ca. 1,7
		Spannung Anschlusswert Absicherung Anschlusskabel, Querschnitt mindestens Länge Anschlusskabel (H05(07)RN-F) mit Stecker	umbaubar	V/Hz kW A mm ² m	AC 230/50 3,4 16 3 × 1,5 ca. 2,1
I		3. Spannung (Lieferzustand) Anschlusswert Absicherung Anschlusskabel, Querschnitt mindestens Länge Anschlusskabel (H05(07)RN-F) ohne Stecker		V/Hz kW A mm ² m	3N AC 400/50 7,1 3 × 16 5 × 2,5 ca. 1,7
		Spannung Anschlusswert Absicherung Anschlusskabel, Querschnitt mindestens Länge Anschlusskabel (H05(07)RN-F) mit Stecker	umbaubar	V/Hz kW A mm ² m	AC 230/50 3,4 16 3 × 1,5 ca. 2,1

		4. Spannung (Lieferzustand) Anschlusswert Absicherung Anschlusskabel, Querschnitt mindestens Länge Anschlusskabel (H05(07)RN-F) ohne Stecker	umbaubar	V/Hz kW A mm ² m	3N AC 400/50 8,9 3 x 15-16 5 x 2,5 ca. 2,1
		Spannung (Lieferzustand) Anschlusswert Absicherung Anschlusskabel, Querschnitt mindestens Länge Anschlusskabel (H05(07)RN-F) mit Stecker	umbaubar	V/Hz kW A mm ² m	AC 230/50 5,9 30-32 3 x 4 ca. 2,1
		Spannung Anschlusswert Absicherung Anschlusskabel, Querschnitt mindestens Länge Anschlusskabel (H05(07)RN-F) mit Stecker	umbaubar	V/Hz kW A mm ² m	AC 230/50 3,4 13-16 3 x 1,5 ca. 2,1
	<p>Es wird empfohlen das Gerät über eine Steckvorrichtung anzuschließen, damit eine elektrische Sicherheitsprüfung einfach durchgeführt werden kann. Die Steckvorrichtung muss nach Geräteinstallation zugänglich sein. Bei Festanschluss des Gerätes ist bauseitig ein Hauptschalter mit allpoliger Trennung vom Netz und mind. 3 mm Kontaktöffnungsweite zu installieren. Zur Erhöhung der Sicherheit wird dringend empfohlen dem Gerät einen Fehlerstromschutzschalter vorzuschalten. Den nationalen Installationsbestimmungen entsprechend, ist gegebenenfalls ein Potentialausgleich herzustellen.</p> <p>Schutzklasse IP21</p>				
	Kaltwasser	Temperatur max. Wasserhärte max. zulässig. Mindestfließdruck Mindestfließdruck bei Einlaufzeitverlängerung maximaler Druck Volumenstrom Anschlussgewinde bauseits nach DIN 44 991 (flachdichtend) Länge Anschlussschlauch (Lieferumfang)		°C °dH kPa kPa kPa l/min Zoll m	20 60 200 40 1.000 7,5 3/4" Außengewinde ca. 1,7
	Warmwasser	Temperatur max. Wasserhärte max. zulässig. Mindestfließdruck Mindestfließdruck bei Einlaufzeitverlängerung maximaler Druck Volumenstrom Anschlussgewinde bauseits nach DIN 44 991 (flachdichtend) Länge Anschlussschlauch (Lieferumfang)		°C °dH kPa kPa kPa l/min Zoll m	65 60 200 40 1.000 7,5 3/4" Außengewinde ca. 1,7
	Abwasser	Ablaufschläuche (di x s) Länge Ablaufschlauch Gewerbegeschirrspüler Länge max. Verlängerung Ablaufschlauch Förderhöhe Ablaufpumpe ab Unterkante Gerät max. Volumenstrom Ablauf kurzzeitig max. Schlauchtülle bauseits je Ablaufschlauch (da x l)		mm m m m l/min mm	22 x 6 ca. 1.5 ca. 4,0 1,0 16 22 x 30
	Dosierung extern (optional)	Anschluss von bis zu zwei Dosiergeräten für flüssigen Reiniger und Klarspülmedien an der Rückwand.			
	Standfuß	Höhe verstellbar Durchmesser Standfuß Aufnahme für Gerätefüße		mm mm M	-0/+60 35 8

	Wärmeabgabe an den Aufstellraum	Wärmeabgabe durch Abstrahlung Wärmeabgabe durch Spülgut bei Entnahme	kWh/h kWh/h	0,35 0,40
	Maschinendaten	Unterbauhöhe Höhe inkl. Deckel (Option, Umbausatz erforderlich) Breite Tiefe Türhöhe Türhöhe mit Tür außenblech-Ausgleich (TAB) Nettogewicht Fußbodenbelastung im Betrieb Einbringbreite inkl. Transportpalette mind. Einbringtiefe inkl. Transportpalette mind. Einbringhöhe inkl. Transportpalette mind.	mm mm mm mm mm mm kg N mm mm mm	820 835 598 580 670 720 70 1.200 670 740 920
	Aufstellbedingungen	Zulässige Umgebungstemperatur rel. Luftfeuchtigkeit max. Aufstellhöhe über NN max. siehe Hinweise in der Gebrauchsanweisung	°C % m	5-40 80 2.000
<p>Die Installationen dürfen nur von konzessionierten Installateuren nach den jeweiligen gültigen Vorschriften, gesetzlichen Grundlagen, den Unfallverhütungsvorschriften und den gültigen Normen durchgeführt werden! Bei Geräteaufstellung unbedingt die Gebrauchsanweisung beachten! Im Umgebungsbereich des Geschirrspülers nur für den gewerblichen Bereich geeignete Möbel/Materialien einsetzen, da sonst eine Beschädigung durch Kondensat möglich ist. Änderungen vorbehalten! Zeichnungsmaße in mm.</p>				

Änderungsnr.	Datum	Bezeichnung:
A20370	10.04.2013	Einführung B0
A29196	01.10.2013	Überarbeitung SOP
A38134	09.06.2015	AC 230/50: 2,9 kW → 3,4 kW
A29163	08.12.2015	+ PT
A41972	08.02.2016	+ TR,
A43503	23.09.2016	Einführung CEE-Stecker für VG Deutschland

Technical data sheet

Miele
PROFESSIONAL

Commercial dishwasher

PG 8056

Legend:







Circled, bold-type abbreviations:
Connection required

GB



Abbreviations surrounded by broken circle:
Connection optional or required, depending on model

EL	Electrical connection	1. Voltage (standard version) Power rating Fuse rating Connection cable, min. gauge Connection cable length (H05(07)RN-F) without plug		V/Hz kW A mm ² m	3N AC 400/50 8.9 3 × 16 5 × 2.5 Approx. 1.7
		Voltage Power rating Fuse rating Connection cable, min. gauge Length of connection cable (H05(07)RN-F) with plug	Convertible	V/Hz kW A mm ² m	AC 230/50 3.4 16 3 × 1.5 Approx. 2.1
Variations in the following countries:					
B N		2. Voltage (standard version) Power rating Fuse rating Connection cable, min. gauge Connection cable length (H05(07)RN-F) without plug		V/Hz kW A mm ² m	3 AC 230/50 7.1 3 × 20 4 × 2.5 Approx. 1.7
		Voltage Power rating Fuse rating Connection cable, min. gauge Length of connection cable (H05(07)RN-F) with plug	Convertible	V/Hz kW A mm ² m	AC 230/50 3.4 16 3 × 1.5 Approx. 2.1
I		3. Voltage (standard version) Power rating Fuse rating Connection cable, min. gauge Connection cable length (H05(07)RN-F) without plug		V/Hz kW A mm ² m	3N AC 400/50 7.1 3 × 16 5 × 2.5 Approx. 1.7
		Voltage Power rating Fuse rating Connection cable, min. gauge Length of connection cable (H05(07)RN-F) with plug	Convertible	V/Hz kW A mm ² m	AC 230/50 3.4 16 3 × 1.5 Approx. 2.1

	4. Voltage (standard version) Power rating Fuse rating Connection cable, min. gauge Connection cable length (H05(07)RN-F) without plug	Convertible	V/Hz kW A mm ² m	3N AC 400/50 8.9 3 x 15-16 5 x 2.5 Approx. 2.1
	Voltage (standard version) Power rating Fuse rating Connection cable, min. gauge Length of connection cable (H05(07)RN-F) with plug	Convertible	V/Hz kW A mm ² m	AC 230/50 5.9 30-32 3 x 4 Approx. 2.1
	Voltage Power rating Fuse rating Connection cable, min. gauge Length of connection cable (H05(07)RN-F) with plug	Convertible	V/Hz kW A mm ² m	AC 230/50 3.4 13-16 3 x 1.5 Approx. 2.1
	<p>It is always recommended to make electrical connection via a plug and socket so that electrical safety checks, e.g. during repair or service work, can be carried out easily. The socket must be accessible after machine installation. A fixed electrical connection is possible via an on-site main switch providing complete isolation from the mains for all poles. The contact gap must be at least 3 mm. In order to increase safety, the installation of an earth leakage circuit breaker is recommended. If necessary, equipotential bonding with good galvanic contact must be guaranteed in compliance with all applicable local and national installation codes.</p> <p>Protection class IP 21</p>			
	Cold water	Maximum temperature Max. water hardness Minimum flow pressure Minimum flow pressure with extended water intake Maximum pressure Flow rate On-site threaded union in accordance with DIN 44991 (flat sealing) Length of connection hose (included)	°C °dH kPa kPa kPa l/min Inch m	20 60 200 40 1000 7.5 3/4" male thread Approx. 1.7
		A double check valve must be fitted when installed in GB.		
	Hot water	Maximum temperature Max. water hardness Minimum flow pressure Minimum flow pressure with extended water intake Maximum pressure Flow rate On-site threaded union in accordance with DIN 44991 (flat sealing) Length of connection hose (included)	°C °dH kPa kPa kPa l/min Inch m	65 60 200 40 1000 7.5 3/4" male thread Approx. 1.7
		A double check valve must be fitted when installed in GB.		
	Waste water	Drain hoses (int. dia. x wall thickness) Length of drain hose - Machine Max. drain hose extension Max. drain pump head height from base of machine Max. transient flow rate On-site hose sleeve for drain hose (dia. x length)	mm m m m l/min mm	22 x 6 Approx. 1.5 Approx. 4.0 1.0 16 22 x 30
	External dispensing (optional)	Connection of up to 2 dispensers for liquid detergent and rinse aid on rear of machine		
	Machine feet	Height-adjustable Machine foot diameter Machine foot socket	mm mm M	-0/+60 35 8

	Heat dissipation rate to installation site	Heat dissipation through heat radiation Load heat dissipation on removal	kWh/h kWh/h	0.35 0.40
	Machine data	Undercounter height Height incl. lid (optional, kit required) Width Depth Door height Door height with door spacer (TAB) Net weight Floor load in operation Min. access width, incl. transport pallet Min. access depth incl. transport pallet Min. access height, incl. transport pallet	mm mm mm mm mm mm kg N mm mm mm	820 835 598 580 670 720 70 1200 670 740 920
	Installation conditions	Permissible ambient temperature Maximum relative humidity Max. installation above sea level c.f. notes in operating instructions	°C % m	5-40 80 2,000
<p>Installation should only be performed by qualified fitters in accordance with valid regulations, relevant standards and health and safety codes!</p> <p>It is important to comply with installation instructions when installing machines! Only use commercial grade cabinetry in the vicinity of this commercial dishwasher as condensate may otherwise cause damage. All rights reserved! Dimensions in drawings in mm.</p>				

Change no.	Date	Designation:
A20370	2013-04-10	B0 launch
A29196	01.10.2013	SOP revision
A38134	2015-06-09	AC 230/50: 2,9 kW → 3,4 kW
A29163	08.12.2015	+ PT
A41972	08.02.2016	+ TR,

Ficha técnica

Miele

PROFESSIONAL

Lavavajillas industrial

PG 8056

Leyenda:







Los símbolos dentro de un círculo en negrita significan: precisa conexión

ES



Las siglas dentro de un círculo discontinuo significan: conexión opcional o necesaria según el modelo del aparato

EL	Conexión eléctrica	1 Tensión (estado de suministro) Potencia nominal Fusible Cable de conexión, sección mínima Longitud del cable de conexión (H05(07)RN-F) sin la clavija		V/Hz kW A mm ² m	3N CA 400/50 8,9 3 x 16 5 x 2,5 1,7 aprox.
		Tensión Potencia nominal Fusible Cable de conexión, sección mínima Longitud del cable de conexión (H05(07)RN-F) con clavija	transformable	V/Hz kW A mm ² m	CA 230/50 3,4 16 3 x 1,5 2,1 aprox.
Valores diferentes a los indicados en los siguientes países:					
B N		2 Tensión (estado de suministro) Potencia nominal Fusible Cable de conexión, sección mínima Longitud del cable de conexión (H05(07)RN-F) sin la clavija		V/Hz kW A mm ² m	3 CA 230/50 7,1 3 x 20 4 x 2,5 1,7 aprox.
		Tensión Potencia nominal Fusible Cable de conexión, sección mínima Longitud del cable de conexión (H05(07)RN-F) con clavija	transformable	V/Hz kW A mm ² m	CA 230/50 3,4 16 3 x 1,5 2,1 aprox.
I		3 Tensión (estado de suministro) Potencia nominal Fusible Cable de conexión, sección mínima Longitud del cable de conexión (H05(07)RN-F) sin la clavija		V/Hz kW A mm ² m	3N CA 400/50 7,1 3 x 16 5 x 2,5 1,7 aprox.
		Tensión Potencia nominal Fusible Cable de conexión, sección mínima Longitud del cable de conexión (H05(07)RN-F) con clavija	transformable	V/Hz kW A mm ² m	CA 230/50 3,4 16 3 x 1,5 2,1 aprox.

		4 Tensión (estado de suministro) Potencia nominal Fusible Cable de conexión, sección mínima Longitud del cable de conexión (H05(07)RN-F) sin la clavija	transformable	V/Hz kW A mm ² m	3N CA 400/50 8,9 3 x 15-16 5 x 2,5 2,1 aprox.
		Tensión (estado de suministro) Potencia nominal Fusible Cable de conexión, sección mínima Longitud del cable de conexión (H05(07)RN-F) con clavija	transformable	V/Hz kW A mm ² m	CA 230/50 5,9 30/-32 3 x 4 2,1 aprox.
		Tensión Potencia nominal Fusible Cable de conexión, sección mínima Longitud del cable de conexión (H05(07)RN-F) con clavija	transformable	V/Hz kW A mm ² m	CA 230/50 3,4 13/-16 3 x 1,5 2,1 aprox.
		Se recomienda conectar el aparato a un conector enchufable a fin de facilitar la realización de un control de la seguridad eléctrica. El conector enchufable debe estar accesible tras la instalación del aparato. En caso de conexión fija del aparato es imprescindible instalar en el lugar de instalación un interruptor principal con desconexión de red para todos los polos, con una anchura de apertura de contacto de al menos 3 mm. A fin de aumentar la seguridad, se recomienda encarecidamente conectar al aparato en serie a un interruptor diferencial. Siguiendo las normativas nacionales sobre instalaciones debe establecerse una conexión equipotencial. Clase de protección IP21			
	Agua fría	Temperatura máx. Dureza máx. admisible del agua. Presión de agua mínima Presión mínima de flujo durante la prolongación del tiempo de ajuste Presión máxima Caudal Racor de conexión en el lugar de instalación según DIN 44 991 (aislante plano) Longitud de la manguera de conexión (volumen de suministro) En caso de conexión debe preverse una grifería de seguridad (double check valve) sólo en GB.	°C °dH kPa kPa kPa l/min Pulgadas m	20 60 200 40 1.000 7,5 3/4" rosca exterior 1,7 aprox.	
	Agua caliente	Temperatura máx. Dureza máx. del agua Presión de agua mínima Presión mínima de flujo durante la prolongación del tiempo de ajuste Presión máxima Caudal Racor de conexión en el lugar de instalación según DIN 44 991 (aislante plano) Longitud de la manguera de conexión (volumen de suministro) En caso de conexión debe preverse una grifería de seguridad (double check valve) sólo en GB.	°C °dH kPa kPa kPa l/min Pulgadas m	65 60 200 40 1.000 7,5 3/4" rosca exterior Aprox.1,7	
	Agua de desagüe	Mangueras de desagüe (di x s) Longitud de la manguera de desagüe del lavavajillas industrial Longitud máxima prolongación de la manguera de desagüe Altura de elevación de la bomba de desagüe desde el borde inferior máx. Caudal del desagüe momentáneo máx. Boquilla para la manguera de desagüe (da x l) (en el lugar de la instalación)	mm m m m l/min mm	22 x 6 1.5 aprox. 4,0 aprox. 1,0 16 22 x 30	

	Dosificación externa(opcional)	Conexión hasta para dos dosificadores para detergente líquido y abrillantadores en la pared posterior.		
	Base de apoyo	Altura regulable Diámetro base de apoyo Alojamiento para las patas del aparato	mm mm M	CA -0/+60 35 8
	Emisión de calor al recinto de emplazamiento	Emisión de calor mediante radiación Emisión de calor mediante utensilios en su extracción	kWh/h kWh/h	0,35 0,40
	Datos de la máquina	Altura bajo encimera Altura incl. tapa (opción, necesario juego de cambio) Anchura Profundidad Altura de puerta Altura de puerta con chapa exterior de puerta-compensación (TAB) Peso neto Carga sobre pavimento en funcionamiento Ancho mín. de carga incl. paleta de transporte Profundidad mín. de carga incl. paleta de transporte Altura mín. de carga incl. paleta de transporte	mm mm mm mm mm mm kg N mm mm mm	820 835 598 580 670 720 70 1.200 670 740 920
	Condiciones de instalación	Temperatura ambiente admisible Humedad rel. del aire máx. Altura de instalación sobre NN máx. véanse indicaciones en las instrucciones de manejo	°C % m	5/-40 80 2.000
<p>¡Las instalaciones se realizarán exclusivamente por fontaneros autorizados ateniéndose a las disposiciones vigentes, las bases legales, las prescripciones para la prevención de accidentes y las normas vigentes!</p> <p>¡Es imprescindible observar las instrucciones de manejo para el emplazamiento del aparato! En el entorno del lavavajillas se deben utilizar sólo muebles / materiales aptos para uso industrial, de lo contrario se pueden producir daños por el agua condensada.</p> <p>¡Salvo modificaciones! Dimensiones de diseño en mm.</p>				

Número de modificación	Fecha	Denominación:
A20370	10.04.2013	Entrada B0
A29196	01.10.2013	Revisión SOP
A38134	09.06.2015	AC 230/50: 2,9 kW → 3,4 kW
A29163	08.12.2015	+ PT
A41972	08.02.2016	+ TR,

Caractéristiques techniques

Miele
PROFESSIONAL

Lave-vaisselle professionnel

PG 8056

Légende :







Les symboles entourés en gras signifient :
Raccordement nécessaire

FR



Les symboles entourés par des pointillés signifient :
Raccordement optionnel ou nécessaire en fonction du modèle
d'appareil

EL	Raccordement électrique	1. Tension (à la livraison) Puissance de raccordement Fusible Câble d'alimentation, section minimum Longueur du câble d'alimentation (H05(07)RN-F) sans fiche		V/Hz kW A mm ² m	3N AC 400/50 8,9 3 × 16 5 × 2,5 env. 1,7
		Tension Puissance de raccordement Fusible Câble d'alimentation, section minimum Longueur du câble de raccordement (H05(07)RN-F) avec fiche	commutable	V/Hz kW A mm ² m	AC 230/50 3,4 16 3 × 1,5 env. 2,1
Spécificités selon les pays :					
B N		2. Tension (à la livraison) Puissance de raccordement Fusible Câble d'alimentation, section minimum Longueur du câble d'alimentation (H05(07)RN-F) sans fiche		V/Hz kW A mm ² m	3 AC 230/50 7,1 3 × 20 4 × 2,5 env. 1,7
		Tension Puissance de raccordement Fusible Câble d'alimentation, section minimum Longueur du câble de raccordement (H05(07)RN-F) avec fiche	commutable	V/Hz kW A mm ² m	AC 230/50 3,4 16 3 × 1,5 env. 2,1
I		3. Tension (à la livraison) Puissance de raccordement Fusible Câble d'alimentation, section minimum Longueur du câble d'alimentation (H05(07)RN-F) sans fiche		V/Hz kW A mm ² m	3N AC 400/50 7,1 3 × 16 5 × 2,5 env. 1,7
		Tension Puissance de raccordement Fusible Câble d'alimentation, section minimum Longueur du câble de raccordement (H05(07)RN-F) avec fiche	commutable	V/Hz kW A mm ² m	AC 230/50 3,4 16 3 × 1,5 env. 2,1

		4. Tension (à la livraison) Puissance de raccordement Fusible Câble d'alimentation, section minimum Longueur du câble d'alimentation (H05(07)RN-F) sans fiche	commutable	V/Hz kW A mm ² m	3N AC 400/50 8,9 3 x 15-16 5 x 2,5 env. 2,1
		Tension (à la livraison) Puissance de raccordement Fusible Câble d'alimentation, section minimum Longueur du câble de raccordement (H05(07)RN-F) avec fiche	commutable	V/Hz kW A mm ² m	AC 230/50 5,9 30-32 3 x 4 env. 2,1
		Tension Puissance de raccordement Fusible Câble d'alimentation, section minimum Longueur du câble de raccordement (H05(07)RN-F) avec fiche	commutable	V/Hz kW A mm ² m	AC 230/50 3,4 13-16 3 x 1,5 env. 2,1
		Il est conseillé de raccorder l'appareil avec une prise conforme afin de pouvoir effectuer facilement les contrôles de sécurité électriques. La prise doit être accessible après l'installation de l'appareil. En cas de raccordement fixe de l'appareil, il faut prévoir un interrupteur principal équipé d'un dispositif de disjonction phases et neutre et une ouverture de contact d'au moins 3 mm. Pour renforcer la sécurité, il est vivement conseillé de monter un disjoncteur différentiel en amont de l'appareil. Conformément aux prescriptions internationales, une liaison équipotentielle doit être établie. Classe de protection IP21			
	Eau froide	Température max. Dureté de l'eau max. admissible Pression minimale Pression minimale lors d'une entrée d'eau prolongée Pression maximale Débit volumétrique Raccord fileté à prévoir par l'exploitant selon DIN 44 991 (joint plat) Longueur tuyau de raccordement (fourni)		°C °dH kPa kPa kPa l/min Pouce m	20 60 200 40 1 000 7,5 3/4" filetage extérieur env. 1,7
	Eau chaude	Température max. Dureté de l'eau max. admissible Pression minimale Pression minimale lors d'une entrée d'eau prolongée Pression maximale Débit volumétrique Raccord fileté à prévoir par l'exploitant selon DIN 44 991 (joint plat) Longueur tuyau de raccordement (fourni)		°C °dH kPa kPa kPa l/min Pouce m	65 60 200 40 1 000 7,5 3/4" filetage extérieur env. 1,7
	Vidange	Tuyaux de vidange (di x s) Longueur du tuyau de vidange du lave-vaisselle professionnel Longueur max. de la rallonge du tuyau de vidange Hauteur de refoulement de la pompe de vidange à partir du rebord inférieur de l'appareil (max.) Débit volumétrique temporaire max. de la vidange Obturateur à prévoir par l'utilisateur par tuyau de vidange (da x l)		mm m m m l/min mm	22 x 6 env. 1.5 env. 4,0 1,0 16 22 x 30
	Dosage externe (en option)	Raccordement jusqu'à deux dispositifs de dosage pour nettoyant et produit de rinçage liquides sur la paroi arrière.			
	Socle	Hauteur réglable Diamètre du socle Emplacement pour les pieds de l'appareil		mm mm M	-0/+60 35 8

	Emission de chaleur dans la pièce d'installation	Emission de chaleur par rayonnement Emission de chaleur par produit de rinçage lors de prélèvement	kWh/h kWh/h	0,35 0,40
	Caractéristiques	Hauteur d'encastrement Hauteur avec couvercle (en option, kit d'adaptation requis) Largeur Profondeur Hauteur de la porte Hauteur de la porte avec équilibrage de la tôle extérieure de la porte (TAB) Poids net Charge au sol en fonctionnement Largeur de chargement minimale de l'appareil avec palette de transport Profondeur de chargement minimale de l'appareil avec palette de transport Hauteur de chargement minimale de l'appareil avec palette de transport	mm mm mm mm mm mm kg N mm mm mm	820 835 598 580 670 720 70 1 200 670 740 920
	Conditions d'installation	Température ambiante admissible Humidité de l'air relative max. Hauteur d'installation max. au-dessus du niveau de la mer (NN) Voir : Suivre les indications dans le mode d'emploi	°C % m	5-40 80 2 000
<p>L'installation doit exclusivement être effectuée par des installateurs agréés, conformément aux prescriptions et aux règlements et aux règlements de prévention des accidents en vigueur. Respecter impérativement le mode d'emploi pour l'installation des appareils ! N'utiliser que des meubles adaptés à un usage industriel à proximité du lave-vaisselle afin d'éviter les dommages éventuels provoqués par la condensation. Sous réserve de modifications ! Dimensions du dessin en mm.</p>				

N° de révision	Date	Désignation :
A20370	10/04/2013	Introduction B0
A29196	01/10/2013	Révision SOP
A38134	09.06.2015	AC 230/50: 2,9 kW → 3,4 kW
A29163	08.12.2015	+ PT
A41972	08.02.2016	+ TR,

Tekninen tiedote

Miele

PROFESSIONAL

Professional-astianpesukone

PG 8056

Merkintöjen selitykset:







Lihavoidut, ympyröidyt merkinnät tarkoittavat:
Liitettä vaaditaan

FI



Katkoviivalla ympyröidyt merkinnät tarkoittavat:
Liitettä valinnainen tai vaaditaan vain tietyissä konetyypeissä

EL	Sähköliitäntä	1. Vakiojännite (tehdastoimitustila) Liitännätäho Sulake Verkkoliitäntäkaapelin poikkipinta-ala vähintään Verkkoliitäntäkaapelin pituus (H05(07)RN-F) ilman pistoketta		V/Hz kW A mm ² m	3N AC 400/50 8,9 3 × 16 5 × 2,5 n. 1,7
		Jännite Liitännätäho Sulake Verkkoliitäntäkaapelin poikkipinta-ala vähintään Verkkoliitäntäkaapelin pituus (H05(07)RN-F) pistokkeen kanssa	muunnettavissa	V/Hz kW A mm ² m	AC 230/50 3,4 16 3 × 1,5 n. 2,1
Tiedot poikkeavat edellisistä seuraavissa maissa:					
B N		2. Vakiojännite (tehdastoimitustila) Liitännätäho Sulake Verkkoliitäntäkaapelin poikkipinta-ala vähintään Verkkoliitäntäkaapelin pituus (H05(07)RN-F) ilman pistoketta		V/Hz kW A mm ² m	3 AC 230/50 7,1 3 × 20 4 × 2,5 n. 1,7
		Jännite Liitännätäho Sulake Verkkoliitäntäkaapelin poikkipinta-ala vähintään Verkkoliitäntäkaapelin pituus (H05(07)RN-F) pistokkeen kanssa	muunnettavissa	V/Hz kW A mm ² m	AC 230/50 3,4 16 3 × 1,5 n. 2,1
I		3. Vakiojännite (tehdastoimitustila) Liitännätäho Sulake Verkkoliitäntäkaapelin poikkipinta-ala vähintään Verkkoliitäntäkaapelin pituus (H05(07)RN-F) ilman pistoketta		V/Hz kW A mm ² m	3N AC 400/50 7,1 3 × 16 5 × 2,5 n. 1,7
		Jännite Liitännätäho Sulake Verkkoliitäntäkaapelin poikkipinta-ala vähintään Verkkoliitäntäkaapelin pituus (H05(07)RN-F) pistokkeen kanssa	muunnettavissa	V/Hz kW A mm ² m	AC 230/50 3,4 16 3 × 1,5 n. 2,1

		4. Vakiojännite (tehdastoimitustila) Liitäntäteho Sulake Verkkoliitäntäkaapelin poikkipinta-ala vähintään Verkkoliitäntäkaapelin pituus (H05(07)RN-F) ilman pistoketta	muunnettavissa	V/Hz kW A mm ² m	3N AC 400/50 8,9 3 x 15-16 5 x 2,5 n. 2,1
		Vakiojännite (tehdastoimitustila) Liitäntäteho Sulake Verkkoliitäntäkaapelin poikkipinta-ala vähintään Verkkoliitäntäkaapelin pituus (H05(07)RN-F) pistokkeen kanssa	muunnettavissa	V/Hz kW A mm ² m	AC 230/50 5,9 30-32 3 x 4 n. 2,1
		Jännite Liitäntäteho Sulake Verkkoliitäntäkaapelin poikkipinta-ala vähintään Verkkoliitäntäkaapelin pituus (H05(07)RN-F) pistokkeen kanssa	muunnettavissa	V/Hz kW A mm ² m	AC 230/50 3,4 13-16 3 x 1,5 n. 2,1
		Suosittelimme koneen liittämistä sähköverkkoon AC 230/50 -kWivan pistotulppaliitännän välityksellä. Tällöin kone on tarvittaessa helppo irrottaa varmasti sähköverkosta. Pistorasiaan on asennuksen jälkeen päästävä helposti käsiksi. Kiinteä sähköliitäntä on varustettava rakennuskohtaisella, kaikki koskettimet avaavalla pääkytkimellä, jonka erotusväli on vähintään 3 mm. Turvallisuuden lisäämiseksi suosittelemme sähköliitännän varustamista vikavirtasuojakytkimellä. Mikäli kansalliset määräykset sitä edellyttävät, liitäntä on varustettava myös potentiaalın tasaimella. Suojausluokka IP21			
	Kylmä vesi	Lämpötila enint. Veden kovuus enintään Tuloveden vähimmäispaine Tuloveden vähimmäispaine, kun vedenottoaika on pidennetty Enimmäispaine Tilavuusvirta DIN 44 991:n mukainen asennuspaikan kierreltiin (litteästi tiivistävä) Liitäntätietkunnan pituus (kuuluu toimitukseen) Liitäntää ei tarvitse varustaa takaisvirtauksen varolaitteella (poikkeuksena Iso-Britannia, jossa edellytetään takaiskuventtiin käyttöä).		°C °dH kPa kPa kPa l/min kierteet m	20 60 200 40 1.000 7,5 3/4" ulkokierteet n. 1,7
	Lämmin vesi	Lämpötila enint. Veden kovuus enintään Tuloveden vähimmäispaine Tuloveden vähimmäispaine, kun vedenottoaika on pidennetty Enimmäispaine Tilavuusvirta DIN 44 991:n mukainen asennuspaikan kierreltiin (litteästi tiivistävä) Liitäntätietkunnan pituus (kuuluu toimitukseen) Liitäntää ei tarvitse varustaa takaisvirtauksen varolaitteella (poikkeuksena Iso-Britannia, jossa edellytetään takaiskuventtiin käyttöä).		°C °dH kPa kPa kPa l/min kierteet m	65 60 200 40 1.000 7,5 3/4" ulkokierteet n.1,7
	Poistovesi	Poistoletkut (sisähalkaisija x vahvuus) Poistovesiletkun pituus Professional-astianpesukoneet Poistovesiletkun jatkokappaleen enimmäispituus Pumpun poistokorkeus enintään (koneen alareunasta laskettuna) Poistoveden tilavuusvirta lyhytaikaisesti enintään Rakennuskohtainen poistoletkun viemäröntiliitin (sisähalkaisija x pituus)		mm m m m l/min mm	22 x 6 n. 1,5 n. 4,0 1,0 16 22 x 30
	Ulkoinen annostelulaite (lisävaruste)	Koneen takaseinässä on kaksi liitäntää nestemäisen pesuaineen ja huuhtelukirkasteiden annostelulaitteita varten.			
	Jalat	Korkeus säädettävissä Jalkojen halkaisija Jalkojen säätömutterin koko		mm mm M	-0/+60 35 8

	Lämmönluovutus sijoitustilaan	Lämmön luovutus, säteilylämpö Lämmönluovutus, astiat konetta tyhjennettäessä	kWh/h kWh/h	0,35 0,40
	Konetiedot	Asennusaukon korkeus Korkeus kansilevyn kanssa (lisävaruste, muuntosarja välttämätön) Leveys Syvyys Luukun korkeus Luukun korkeus luukun etulevyn tasauslistan kanssa (TAB) Nettopaino Lattiaan kohdistuva kuormitus käytön aikana Kuljetuslavan ja koneen vaatima sisääntuloaukon leveys vähint. Kuljetuslavan ja koneen vaatima sisääntulosyvyys vähint. Kuljetuslavan ja koneen vaatima sisääntulokorkeus vähint.	mm mm mm mm mm kg N mm mm mm	820 835 598 580 670 720 70 1.200 670 740 920
	Sijoitustilan edellytykset	Ympäristön lämpötila Ilman suhteellinen kosteus enintään Sijoituspaikan korkeus merenpinnasta enint. ks. koneen käyttöohje	°C % m	5-40 80 2.000
<p>Asennustyöt on ehdottomasti jätettävä vain sellaisten valtuutettujen sähköasentajien tehtäväksi, jotka tuntevat paikalliset määräykset, lakisääteiset työsuojelumääräykset ja voimassa olevat standardit! Noudata koneen käyttöohjetta! Astianpesukoneen välittömään läheisyyteen saa asentaa vain laitoskäyttöön tarkoitettuja kalusteita ja materiaaleja, niin vältytään koneesta haihtuvan vesihöyryn aiheuttamilta vaurioilta. Oikeus muutoksiin pidätetään! Piirrosten mitat ovat millimetrejä (mm).</p>				

Versionro	Päiväys	Kuvaus:
A20370	10.04.2013	Laatinut B0
A29196	1.10.2013	Muokkaus SOP
A38134	09.06.2015	AC 230/50: 2,9 kW → 3,4 kW
A29163	08.12.2015	+ PT
A41972	08.02.2016	+ TR,

Tekniska data

Miele
PROFESSIONAL

Diskmaskin för professionellt bruk

PG 8056

Förteckning:







Inringade förkortningar betyder att anslutning krävs.

SE





Förkortningar som omges av streck och punkter betyder att anslutning är möjlig eller krävs, beroende på maskinmodell.





	Elanslutning	1. Spänning (leveransutförande) Anslutningsvärde Säkring Anslutningskabel, minsta tvärsnittsarea Längd anslutningskabel (H05(07)RN-F) utan stickkontakt		V/Hz kW A mm ² m	3N AC 400/50 8,9 3 × 16 5 × 2,5 ca 1,7
		Spänning Anslutningsvärde Säkring Anslutningskabel, minsta tvärsnittsarea Längd anslutningskabel (H05(07)RN-F) med stickkontakt	ändringsbar	V/Hz kW A mm ² m	AC 230/50 3,4 16 3 × 1,5 ca 2,1
Avvikelser från ovanstående i följande länder:					
 		2. Spänning (leveransutförande) Anslutningsvärde Säkring Anslutningskabel, minsta tvärsnittsarea Längd anslutningskabel (H05(07)RN-F) utan stickkontakt		V/Hz kW A mm ² m	3 AC 230/50 7,1 3 × 20 4 × 2,5 ca 1,7
		Spänning Anslutningsvärde Säkring Anslutningskabel, minsta tvärsnittsarea Längd anslutningskabel (H05(07)RN-F) med stickkontakt	ändringsbar	V/Hz kW A mm ² m	AC 230/50 3,4 16 3 × 1,5 ca 2,1
		3. Spänning (leveransutförande) Anslutningsvärde Säkring Anslutningskabel, minsta tvärsnittsarea Längd anslutningskabel (H05(07)RN-F) utan stickkontakt		V/Hz kW A mm ² m	3N AC 400/50 7,1 3 × 16 5 × 2,5 ca 1,7
		Spänning Anslutningsvärde Säkring Anslutningskabel, minsta tvärsnittsarea Längd anslutningskabel (H05(07)RN-F) med stickkontakt	ändringsbar	V/Hz kW A mm ² m	AC 230/50 3,4 16 3 × 1,5 ca 2,1





		4. Spänning (leveransutförande) Anslutningsvärde Säkring Anslutningskabel, minsta tvärsnittsarea Längd anslutningskabel (H05(07)RN-F) utan stickkontakt	ändringsbar	V/Hz kW A mm ² m	3N AC 400/50 8,9 3 x 15-16 5 x 2,5 ca 2,1
		Spänning (leveransutförande) Anslutningsvärde Säkring Anslutningskabel, minsta tvärsnittsarea Längd anslutningskabel (H05(07)RN-F) med stickkontakt	ändringsbar	V/Hz kW A mm ² m	AC 230/50 5,9 30-32 3 x 4 ca 2,1
		Spänning Anslutningsvärde Säkring Anslutningskabel, minsta tvärsnittsarea Längd anslutningskabel (H05(07)RN-F) med stickkontakt	ändringsbar	V/Hz kW A mm ² m	AC 230/50 3,4 13-16 3 x 1,5 ca 2,1
		Det rekommenderas att maskinen ansluts till ett sådant uttag att en elektrisk säkerhetskontroll enkelt kan genomföras. Uttaget måste vara åtkomligt efter installation av maskinen. Om maskinen har en fast anslutning, ska en huvudbrytare installeras på uppställningsplatsen med allpolig brytning och minst 3 mm stor kontaktöppning. För att höja säkerheten rekommenderas starkt att en jordfelsbrytare kopplas före maskinen. Om det krävs enligt nationella bestämmelser, ska även en potentialutjämning med god kontakt skapas. Skyddsklass IP21			
	Kallvatten	Temperatur, max. Tillåten vattenhårdhet, max. Lägsta flödestryck Lägsta flödestryck vid förlängning av inflödestiden Tryck, max. Flöde Anslutningsgänga på uppställningsplatsen enligt DIN 44 991 (flatbottentätande) Längd anslutningsslang (leveransmått) I Storbritannien krävs en säkerhetsarmatur vid anslutningen (double check valve).	°C °dH kPa kPa kPa l/min tum m	20 60 200 40 1 000 7,5 3/4" yttergänga ca 1,7	
	Varmvatten	Temperatur, max. Tillåten vattenhårdhet, max. Lägsta flödestryck Lägsta flödestryck vid förlängning av inflödestiden Tryck, max. Flöde Anslutningsgänga på uppställningsplatsen enligt DIN 44 991 (flatbottentätande) Längd anslutningsslang (leveransmått) I Storbritannien krävs en säkerhetsarmatur vid anslutningen (double check valve).	°C °dH kPa kPa kPa l/min tum m	65 60 200 40 1 000 7,5 3/4" yttergänga ca 1,7	
	Avloppsvatten	Avloppsslangar (innerdiameter x grovlek) Längd avloppsslang, diskmaskin för prof. bruk Längd förlängning av avloppsslang, max. Avloppspumpens matningshöjd från diskmaskinens underkant, max. Flöde under toppar, max. Anslutningsstuts för avloppsslangen på uppställningsplatsen (ytterdiameter x längd)	mm m m m l/min mm	22 x 6 ca 1,7 ca 4,0 1,0 16 22 x 30	
	Extern dosering (tillval)	På baksidan kan man ansluta upp till två doseringspumpar för flytande diskmedel respektive spolglans.			
	Ställfot	Reglerbar höjd Ställfot, diameter Gänga för maskinfötter	mm mm M	-0/+60 35 8	

	Värmeavgivning i uppställnings-lokalen	Värmestrålning Värmeavgivning från diskgoods vid urlastning	kWh/h kWh/h	0,35 0,40
	Maskindata	Inbyggnadshöjd Höjd inklusive topplock (tillval, ombyggnadssats krävs) Bredd Djup Höjd lucka Höjd lucka med ytterplåtsutjämning (TAB) Nettovikt Golvbelastning under drift Nischbredd inkl. transportpall, minst Nischdjup inkl. transportpall, minst Nischhöjd inkl. transportpall, minst	mm mm mm mm mm mm kg N mm mm mm	820 835 598 580 670 720 70 1 200 670 740 920
	Villkor på uppställnings-platsen	Tillåten rumstemperatur Relativ luftfuktighet, max. Uppställningshöjd över havet, max. Se anvisningarna i bruksanvisningen.	°C % m	5-40 80 2 000
<p>Endast godkända installatörer får utföra installationerna, och det måste ske i enlighet med gällande föreskrifter, lagar samt olycksfallsförebyggande bestämmelser och normer! Bruksanvisningen ska absolut följas. Använd endast lämpliga möbler/material i utrymmet där diskmaskinen för professionellt bruk står. Det finns annars risk för att kondens kan skada dessa föremål. Med reservation för ändringar. Skissmått i mm.</p>				

Ändringsnr	Datum	Beteckning:
A20370	2013-04-10	Introduktion B0
A29196	2013-10-01	Omarbetning SOP
A38134	09.06.2015	AC 230/50: 2,9 kW → 3,4 kW
A29163	08.12.2015	+ PT
A41972	08.02.2016	+ TR,

Signaturforklaring:  Forkortelser med ring omkring betyder: Tilslutning påkrævet
DK
 Forkortelser med brudt ring omkring betyder: Tilslutning valgfri eller påkrævet afhængig af maskinudførelse

	Etilslutning	1. Spænding (ved levering) Tilslutningsværdi Sikring Tilslutningsledning, tværsnit min. Længde tilslutningsledning (H05(07)RN-F) uden stik		V/Hz kW A mm ² m	3N AC 400/50 8,9 3 × 16 5 × 2,5 ca. 1,7
		Spænding Tilslutningsværdi Sikring Tilslutningsledning, tværsnit min. Længde tilslutningsledning (H05(07)RN-F) med stik	Kan ombygges	V/Hz kW A mm ² m	AC 230/50 3,4 16 3 × 1,5 ca. 2,1
Afgivelser herfra i følgende lande:					
 		2. Spænding (ved levering) Tilslutningsværdi Sikring Tilslutningsledning, tværsnit min. Længde tilslutningsledning (H05(07)RN-F) uden stik		V/Hz kW A mm ² m	3 AC 230/50 7,1 3 × 20 4 × 2,5 ca. 1,7
		Spænding Tilslutningsværdi Sikring Tilslutningsledning, tværsnit min. Længde tilslutningsledning (H05(07)RN-F) med stik	Kan ombygges	V/Hz kW A mm ² m	AC 230/50 3,4 16 3 × 1,5 ca. 2,1
		3. Spænding (ved levering) Tilslutningsværdi Sikring Tilslutningsledning, tværsnit min. Længde tilslutningsledning (H05(07)RN-F) uden stik		V/Hz kW A mm ² m	3N AC 400/50 7,1 3 × 16 5 × 2,5 ca. 1,7
		Spænding Tilslutningsværdi Sikring Tilslutningsledning, tværsnit min. Længde tilslutningsledning (H05(07)RN-F) med stik	Kan ombygges	V/Hz kW A mm ² m	AC 230/50 3,4 16 3 × 1,5 ca. 2,1

	4. Spænding (ved levering) Tilslutningsværdi Sikring Tilslutningsledning, tværsnit min. Længde tilslutningsledning (H05(07)RN-F) uden stik	Kan ombygges	V/Hz kW A mm ² m	3N AC 400/50 8,9 3 x 15-16 5 x 2,5 ca. 2,1
	Spænding (ved levering) Tilslutningsværdi Sikring Tilslutningsledning, tværsnit min. Længde tilslutningsledning (H05(07)RN-F) med stik	Kan ombygges	V/Hz kW A mm ² m	AC 230/50 5,9 30-32 3 x 4 ca. 2,1
	Spænding Tilslutningsværdi Sikring Tilslutningsledning, tværsnit min. Længde tilslutningsledning (H05(07)RN-F) med stik	Kan ombygges	V/Hz kW A mm ² m	AC 230/50 3,4 13-16 3 x 1,5 ca. 2,1
	<p>Det anbefales at tilslutte maskinen via et stik, således at der let kan foretages en elektrisk sikkerhedskontrol. Stikket skal være let tilgængeligt efter installation af maskinen. Ved fast tilslutning af maskinen skal der på opstillingsstedet installeres en hovedkontakt med flerpolet adskillelse fra nettet og en kontaktåbningsbredde på min. 3 mm. Til forøgelse af sikkerheden anbefales et fejlstrømsrelæ. I henhold til de nationale installationsbestemmelser skal der foretages en potentialudligning.</p> <p>Beskyttelsesklasse IP21</p>			
	Koldt vand	Maks. temperatur Maks. tilladte vandhårdhed Min. flydetryk Min. flydetryk ved forlænget indløbstid Maks. tryk Volumenstrøm Tilslutningsgevind iht. DIN 44 991 (fladpakning) på opstillingsstedet Længde på tilslutningsslange (medfølger)	°C °dH kPa kPa kPa l/min. tomme m	20 60 200 40 1.000 7,5 3/4" udvendigt gevind ca. 1,7
	Varmt vand	Maks. temperatur Maks. tilladte vandhårdhed Min. flydetryk Min. flydetryk ved forlænget indløbstid Maks. tryk Volumenstrøm Tilslutningsgevind iht. DIN 44 991 (fladpakning) på opstillingsstedet Længde på tilslutningsslange (medfølger)	°C °dH kPa kPa kPa l/min. tomme m	65 60 200 40 1.000 7,5 3/4" udvendigt gevind ca. 1,7
	Afløbsvand	Afløbsslanger (dia x t) Længde på afløbsslange industriopvaskemaskine Maks. længde afløbsslangeforlængelse Udpumpningshøjde afløbspumpe fra underkanten af maskinen, maks. Volumenstrøm afløb kortvarigt, maks. Spændebånd på opstillingsstedet til hver afløbsslange (dia x l)	mm m m m l/min. mm	22 x 6 ca. 1.5 ca. 4,0 1,0 16 22 x 30
	Ekstern dosering (option)	Tilslutning af op til 2 doseringsanlæg til flydende opvaskemiddel og afspændingsmiddel på bagsiden.		
	Maskinben	Justerbar i højden Diameter maskinben Holder til maskinben	mm mm M	-0/+60 35 8

	Varmeafgivelse til opstillingsrummet	Varmeafgivelse ved stråling Varmeafgivelse fra genstande ved udtagning	kWh/t. kWh/t.	0,35 0,40
	Maskindata	Underbygningshøjde Højde med topplade (ekstraudstyr, ombygningssæt påkrævet) Bredde Dybde Dørhøjde Dørhøjde med pyntefront på døryderside (TAB) Nettovægt Gulvbelastning under brug Min. bredde på transportåbning (inkl. transportpalle) Min. dybde på transportåbning (inkl. transportpalle) Min. højde på transportåbning (inkl. transportpalle)	mm mm mm mm mm mm kg N mm mm mm	820 835 598 580 670 720 70 1.200 670 740 920
	Opstillingsbetingelser	Tilladt omgivelsestemperatur Rel. luftfugtighed, maks. Opstillingshøjde over normalnul, maks. Se vejledninger i brugsanvisning	°C % m	5-40 80 2.000
<p>Installation må kun foretages af en autoriseret installatør i henhold til de gældende lovbestemmelser, de ulykkesforebyggende forskrifter og gældende normer! Ved opstilling af maskinen skal brugsanvisningen ubetinget følges! I området omkring maskinen må kun anvendes møbler/materialer til erhvervsmæssig brug, da der ellers kan opstå beskadigelser på grund af kondensat. Med forbehold for ændringer! Mål på tegning i mm.</p>				

Ændrings-nr.	Dato	Betegnelse:
A20370	10.04.2013	Introduktion B0
A29196	01.10.2013	Revidering SOP
A38134	09.06.2015	AC 230/50: 2,9 kW → 3,4 kW
A29163	08.12.2015	+ PT
A41972	08.02.2016	+ TR,

Dati tecnici

Miele
PROFESSIONAL

Lavastoviglie industriale

PG 8056

Legenda:







Significato delle sigle cerchiato in grassetto
Allacciamento necessario



Significato delle sigle cerchiato in tratteggio
Allacciamento necessario o opzionale a seconda della versione

IT

EL	Allacciamento elettrico	1. Tensione (al momento della fornitura) Potenza assorbita Protezione Sezione minima cavo di alimentazione Lunghezza cavo di allacciamento (H05(07)RN-F) senza spina		V/Hz kW A mm ² m	3N AC 400/50 8,9 3 × 16 5 × 2,5 ca. 1,7
		Tensione Potenza assorbita Protezione Sezione minima cavo di alimentazione Lunghezza cavo di allacciamento (H05(07)RN-F) con spina	modificabile	V/Hz kW A mm ² m	AC 230/50 3,4 16 3 × 1,5 ca. 2,1
Valori diversi nei seguenti paesi:					
B N		2. Tensione (al momento della fornitura) Potenza assorbita Protezione Sezione minima cavo di alimentazione Lunghezza cavo di allacciamento (H05(07)RN-F) senza spina		V/Hz kW A mm ² m	3 AC 230/50 7,1 3 × 20 4 × 2,5 ca. 1,7
		Tensione Potenza assorbita Protezione Sezione minima cavo di alimentazione Lunghezza cavo di allacciamento (H05(07)RN-F) con spina	modificabile	V/Hz kW A mm ² m	AC 230/50 3,4 16 3 × 1,5 ca. 2,1
I		3. Tensione (al momento della fornitura) Potenza assorbita Protezione Sezione minima cavo di alimentazione Lunghezza cavo di allacciamento (H05(07)RN-F) senza spina		V/Hz kW A mm ² m	3N AC 400/50 7,1 3 × 16 5 × 2,5 ca. 1,7
		Tensione Potenza assorbita Protezione Sezione minima cavo di alimentazione Lunghezza cavo di allacciamento (H05(07)RN-F) con spina	modificabile	V/Hz kW A mm ² m	AC 230/50 3,4 16 3 × 1,5 ca. 2,1

		4. Tensione (al momento della fornitura) Potenza assorbita Protezione Sezione minima cavo di alimentazione Lunghezza cavo di allacciamento (H05(07)RN-F) senza spina	modificabile	V/Hz kW A mm ² m	3N AC 400/50 8,9 3 x 15-16 5 x 2,5 ca. 2,1
		Tensione (al momento della fornitura) Potenza assorbita Protezione Sezione minima cavo di alimentazione Lunghezza cavo di allacciamento (H05(07)RN-F) con spina	modificabile	V/Hz kW A mm ² m	AC 230/50 5,9 30-32 3 x 4 ca. 2,1
		Tensione Potenza assorbita Protezione Sezione minima cavo di alimentazione Lunghezza cavo di allacciamento (H05(07)RN-F) con spina	modificabile	V/Hz kW A mm ² m	AC 230/50 3,4 13-16 3 x 1,5 ca. 2,1
		Si consiglia di allacciare la macchina con una spina in modo che ne possa essere agevolmente controllata la sicurezza elettrica. La spina deve essere accessibile anche a macchina installata. In caso di allacciamento fisso, provvedere a installare un interruttore generale con separazione di tutti i poli dalla rete e con apertura di contatto di almeno 3 mm. Per rendere la macchina ancora più sicura, si consiglia di preporre un interruttore differenziale (salvavita). Installare eventualmente anche la messa a terra in conformità alle disposizioni nazionali vigenti. Classe di protezione IP21			
	Acqua fredda	Temperatura max. max. durezza dell'acqua ammissa Pressione flusso min. Pressione minima di flusso con prolungamento durata afflusso Pressione max. Flusso Raccordo allacciamento (committente) conforme a DIN 44 991 (guarnizione piatta) Lunghezza tubo di allacciamento (dotazione) Al momento dell'allacciamento, solo in Gran Bretagna occorre predisporre una valvola di protezione (double check valve).		°C °dH kPa kPa kPa l/min Pollice m	20 60 200 40 1.000 7,5 3/4" raccordo esterno ca. 1,7
	acqua calda	Temperatura max. max. durezza dell'acqua ammissa Pressione flusso min. Pressione minima di flusso con prolungamento durata afflusso Pressione max. Flusso Raccordo allacciamento (committente) conforme a DIN 44 991 (guarnizione piatta) Lunghezza tubo di allacciamento (dotazione) Al momento dell'allacciamento, solo in Gran Bretagna occorre predisporre una valvola di protezione (double check valve).		°C °dH kPa kPa kPa l/min Pollice m	65 60 200 40 1.000 7,5 3/4" raccordo esterno ca.1,7
	Acqua scarico	Tubi di scarico (di x s) Lunghezza tubo di scarico lavastoviglie industriale Lunghezza max. prolungamento tubo di scarico Prevalenza max. pompa di scarico da bordo inferiore macchina Flusso volumetrico scarico max. per breve periodo Beccuccio per tubo di scarico (committente) (da x l)		mm m m m l/min mm	22 x 6 ca. 1,5 ca. 4,0 1,0 16 22 x 30
	Dosaggio esterno (opzionale)	Allacciamento di max. due dosatori per detersivo liquido e brillantante sul retro.			
	Piede d'appoggio	Altezza regolabile Diametro piede d'appoggio Inserito per piedini		mm mm M	-0/+60 35 8

	Cessione di calore sul luogo di posizionamento	Cessione di calore per irradiazione Cessione di calore dal carico quando lo si preleva	kWh/h kWh/h	0,35 0,40
	Dati macchina	Altezza sottopiano Altezza compreso coperchio (opzionale, necessario kit di modifica) Larghezza Profondità Altezza sportello Altezza sportello con compensazione lamiera esterna sportello (TAB) Peso a vuoto Sollecitazione a pavimento durante il funzionamento Larghezza accesso compr. pallet trasporto min. Profondità ingresso compr. Pallet trasporto min. Altezza ingresso compr. pallet trasporto min.	mm mm mm mm mm kg N mm mm mm	820 835 598 580 670 720 70 1.200 670 740 920
	Condizioni di posizionamento	Temperatura ambiente consentita Umidità dell'aria relativa max. Altezza di posizionamento AC 230/50 - kWra NN max. v. indicazioni nelle istruzioni d'uso	°C % m	5-40 80 2.000
<p>L'installazione può essere effettuata esclusivamente da tecnici qualificati e autorizzati, nel rispetto delle norme vigenti a livello nazionale in materia di sicurezza, prevenzione degli infortuni ecc.</p> <p>Per il posizionamento della macchina, attenersi alle istruzioni di montaggio! Nell'area adiacente alla lavastoviglie utilizzare solo mobili/materiali adatti all'uso industriale altrimenti è possibile che si danneggino a causa della condensa. Salvo modifiche. Misure in mm</p>				

N. modifica	Data	Definizione
A20370	10.04.2013	Introduzione B0
A29196	01.10.2013	Rielaborazione SOP
A38134	09.06.2015	AC 230/50: 2,9 kW → 3,4 kW
A29163	08.12.2015	+ PT
A41972	08.02.2016	+ TR,

Teknisk datablad

Miele
PROFESSIONAL

Industrioppvaskmaskin

PG 8056

Legende:







Innringede symboler med fet skrift betyr:
Tilkobling nødvendig



Stiplet innringede symboler betyr:
Tilkobling valgfri eller avhengig av maskinmodell

NO

EL	Elektrotilkobling	1. Spenning (fabrikinnstilling) Effekt Sikring Tilkoblingskabel, tverrsnitt minst Lengde på tilkoblingskabel (H05(07)RN-F) uten plugg		V/Hz kW A mm ² m	3N AC 400/50 8,9 3 × 16 5 × 2,5 ca. 1,7
		Spenning Effekt Sikring Tilkoblingskabel, tverrsnitt minst Lengde på tilkoblingskabel (H05(07)RN-F) med plugg	kan ombygges	V/Hz kW A mm ² m	AC 230/50 3,4 16 3 × 1,5 ca. 2,1
Avvik fra dette i følgende land:					
B N		2. Spenning (fabrikinnstilling) Effekt Sikring Tilkoblingskabel, tverrsnitt minst Lengde på tilkoblingskabel (H05(07)RN-F) uten plugg		V/Hz kW A mm ² m	3 AC 230/50 7,1 3 × 20 4 × 2,5 ca. 1,7
		Spenning Effekt Sikring Tilkoblingskabel, tverrsnitt minst Lengde på tilkoblingskabel (H05(07)RN-F) med plugg	kan ombygges	V/Hz kW A mm ² m	AC 230/50 3,4 16 3 × 1,5 ca. 2,1
I		3. Spenning (fabrikinnstilling) Effekt Sikring Tilkoblingskabel, tverrsnitt minst Lengde på tilkoblingskabel (H05(07)RN-F) uten plugg		V/Hz kW A mm ² m	3N AC 400/50 7,1 3 × 16 5 × 2,5 ca. 1,7
		Spenning Effekt Sikring Tilkoblingskabel, tverrsnitt minst Lengde på tilkoblingskabel (H05(07)RN-F) med plugg	kan ombygges	V/Hz kW A mm ² m	AC 230/50 3,4 16 3 × 1,5 ca. 2,1

		4. Spenning (fabrikkinstilling) Effekt Sikring Tilkoblingskabel, tverrsnitt minst Lengde på tilkoblingskabel (H05(07)RN-F) uten plugg	kan ombygges	V/Hz kW A mm ² m	3N AC 400/50 8,9 3 x 15-16 5 x 2,5 ca. 2,1
		Spenning (fabrikkinstilling) Effekt Sikring Tilkoblingskabel, tverrsnitt minst Lengde på tilkoblingskabel (H05(07)RN-F) med plugg	kan ombygges	V/Hz kW A mm ² m	AC 230/50 5,9 30-32 3 x 4 ca. 2,1
		Spenning Effekt Sikring Tilkoblingskabel, tverrsnitt minst Lengde på tilkoblingskabel (H05(07)RN-F) med plugg	kan ombygges	V/Hz kW A mm ² m	AC 230/50 3,4 13-16 3 x 1,5 ca. 2,1
		Det anbefales å koble maskinen til en stikkontakt, slik at det lett kan gjennomføres en elektrisk sikkerhetstest. Stikkontakten må være tilgjengelig etter installasjonen av maskinen. Ved fast tilkobling av maskinen skal det på oppstillingsstedet installeres en hovedbryter med allpolet deling fra nettet og minimum 3 mm kontaktavstand. For å høyne sikkerheten anbefales det absolutt å koble maskinen til en jordfeilbryter. I henhold til de nasjonale installasjonsbestemmelsene skal det evt. lages en potensialutjevning med god kontaktforbindelse. Kapslingsgrad IP21			
	Kaldtvann	Temperatur maks. Vannets hardhet maks.tillatt Minste flytetrykk Minste flytetrykk ved inntaksforlengelse Maksimalt trykk Gjennomstrømningsmengde Tilkoblingsgjenge på oppstillingsstedet iflg. DIN 44 991 Lengde på tilkoblingslange (medfølger) Ved tilkobling er det kun i Storbritannia at det skal sørges for sikringsarmatur (double check valve = dobbelt tilbakeslagsventil).		°C °dH kPa kPa kPa l/min tomme m	20 60 200 40 1.000 7,5 3/4" utvendig gjenge ca. 1,7
	Varmtvann	Temperatur maks. Vannets hardhet maks.tillatt Minste flytetrykk Minste flytetrykk ved inntaksforlengelse Maksimalt trykk Gjennomstrømningsmengde Tilkoblingsgjenge på oppstillingsstedet iflg. DIN 44 991 Lengde på tilkoblingslange (medfølger) Ved tilkobling er det kun i Storbritannia at det skal sørges for sikringsarmatur (double check valve = dobbelt tilbakeslagsventil).		°C °dH kPa kPa kPa l/min tomme m	65 60 200 40 1.000 7,5 3/4" utvendig gjenge ca.1,7
	Avløpsvann	Avløpsslanger (innvendig Ø x godstykkelse) Lengde på avløpsslange til industrioppvaskmaskinen Lengde på maks. forlengelse for avløpsslangen Løftehøyde på avløpspumpen fra underkanten av maskinen maks. Gjennomstrømningsmengde for avløp kortvarig maks. Slangestuss på oppstillingsstedet pr. avløpsslange (utvendig Ø x lengde)		mm m m m l/min mm	22 x 6 ca. 1.5 ca. 4,0 1,0 16 22 x 30
	Dosering ekstern (opsjonal)	Tilkobling av inntil to doseringsapparater for flytende rengjøringsmiddel og glansmiddel på bakveggen.			
	Fot	Justerbar høyde Diameter fot Holder for maskinføtter		mm mm M	-0/+60 35 8

	Varmeavgivelse til oppstillingsrommet	Varmeavgivelse ved utstråling Varmeavgivelse ved uttagning av serviset	kWh/h kWh/h	0,35 0,40
	Maskindata	Innbygningshøyde Høyde inkl. deksel (opsjon, ombyggningssett nødvendig) Bredde Dybde Dørhøyde Dørhøyde med utvidelse av utvendig dørblad (TAB) Nettvekt Gulvbelastning under drift Minste bredde for inntransportering inkl. transportpall Minste dybde for inntransportering inkl. transportpall Minste høyde for inntransportering inkl. transportpall	mm mm mm mm mm mm kg N mm mm mm	820 835 598 580 670 720 70 1.200 670 740 920
	Oppstillingsbetingelser	Tillatt omgivelsestemperatur Rel. luftfuktighet maks. Oppstillingshøyde over NN maks. Se råd i bruksanvisningen	°C % m	5-40 80 2.000
<p>Installasjonene skal kun utføres av installatører med konsesjon i overensstemmelse med de til enhver tid gjeldende forskrifter, lovbestemmelser, ulykkesforebyggende forskrifter og gyldige normer.</p> <p>Ved oppstilling av maskinen skal monteringsveiledningen absolutt følges. I området rundt oppvaskmaskinen bør det kun monteres møbler/materiell som egner seg for industri, da det ellers kan oppstå skader på grunn av kondensat. Det tas forbehold om endringer! Tegningsmål i mm.</p>				

Endringsnr.	Dato	Betegnelse:
A20370	10.04.2013	Innføring B0
A29196	01.10.2013	Gjennomarbeidelse SOP
A38134	09.06.2015	AC 230/50: 2,9 kW → 3,4 kW
A29163	08.12.2015	+ PT
A41972	08.02.2016	+ TR,

Technische gegevens

Miele
PROFESSIONAL

Bedrijfsafwasautomaat

PG 8056

Legenda:







Geheel omcirkelde afkortingen betekenen:
aansluiting vereist

NL



Niet geheel omcirkelde afkortingen betekenen:
optioneel of afhankelijk van het apparaat is aansluiting vereist

(EL)	Elektrische aansluiting	1. Spanning (af fabriek) Aansluitwaarde Zekering Aansluitkabel, draaddoorsnede, minimaal Lengte aansluitkabel (H05(07)RN-F) zonder stekker		V/Hz kW A mm ² m	3N AC 400/50 8,9 3 × 16 5 × 2,5 ca. 1,7
		Spanning Aansluitwaarde Zekering Aansluitkabel, draaddoorsnede, minimaal Lengte aansluitkabel (H05(07)RN-F) met stekker	om te bouwen	V/Hz kW A mm ² m	AC 230/50 3,4 16 3 × 1,5 ca. 2,1
Hiervan afwijkend geldt in de volgende landen:					
(B) (N)		2. Spanning (af fabriek) Aansluitwaarde Zekering Aansluitkabel, draaddoorsnede, minimaal Lengte aansluitkabel (H05(07)RN-F) zonder stekker		V/Hz kW A mm ² m	3 AC 230/50 7,1 3 × 20 4 × 2,5 ca. 1,7
		Spanning Aansluitwaarde Zekering Aansluitkabel, draaddoorsnede, minimaal Lengte aansluitkabel (H05(07)RN-F) met stekker	om te bouwen	V/Hz kW A mm ² m	AC 230/50 3,4 16 3 × 1,5 ca. 2,1
(I)		3. Spanning (af fabriek) Aansluitwaarde Zekering Aansluitkabel, draaddoorsnede, minimaal Lengte aansluitkabel (H05(07)RN-F) zonder stekker		V/Hz kW A mm ² m	3N AC 400/50 7,1 3 × 16 5 × 2,5 ca. 1,7
		Spanning Aansluitwaarde Zekering Aansluitkabel, draaddoorsnede, minimaal Lengte aansluitkabel (H05(07)RN-F) met stekker	om te bouwen	V/Hz kW A mm ² m	AC 230/50 3,4 16 3 × 1,5 ca. 2,1

	4. Spanning (af fabriek) Aansluitwaarde Zekering Aansluitkabel, draaddoorsnede, minimaal Lengte aansluitkabel (H05(07)RN-F) zonder stekker	om te bouwen	V/Hz kW A mm ² m	3N AC 400/50 8,9 3 x 15-16 5 x 2,5 ca. 2,1
	Spanning (af fabriek) Aansluitwaarde Zekering Aansluitkabel, draaddoorsnede, minimaal Lengte aansluitkabel (H05(07)RN-F) met stekker	om te bouwen	V/Hz kW A mm ² m	AC 230/50 5,9 30-32 3 x 4 ca. 2,1
	Spanning Aansluitwaarde Zekering Aansluitkabel, draaddoorsnede, minimaal Lengte aansluitkabel (H05(07)RN-F) met stekker	om te bouwen	V/Hz kW A mm ² m	AC 230/50 3,4 13-16 3 x 1,5 ca. 2,1
	<p>Het is aan te bevelen het apparaat met een stekker aan te sluiten, zodat de elektrische veiligheid eenvoudig kan worden gecontroleerd. Deze stekker moet ook na de installatie van het apparaat toegankelijk zijn. Bij een vaste aansluiting moet ter plaatse een hoofdschakelaar worden geïnstalleerd, waarmee het apparaat met alle polen van de netspanning kan worden losgekoppeld. De contactopening dient minimaal 3 mm te zijn. Een aardlekschakelaar wordt dringend aanbevolen! Het apparaat moet volgens de daarvoor geldende voorschriften worden geaard!</p> <p>Veiligheidsklasse IP21</p>			
	Koud water	Temperatuur max. Waterhardheid max. toegestaan Minimale waterdruk Minimale waterdruk bij verlenging van de toevoertijd Maximale waterdruk Volumestroom Slangkoppeling ter plaatse volgens DIN 44 991 (vlakdichtend) Lengte aansluitslang (bijgeleverd)	°C °dH kPa kPa kPa l/min inch/Zoll m	20 60 200 40 1.000 7,5 3/4" buitenschroefdr. ca. 1,7
	Warm water	Temperatuur max. Waterhardheid max. toegestaan Minimale waterdruk Minimale waterdruk bij verlenging van de toevoertijd Maximale waterdruk Volumestroom Slangkoppeling ter plaatse volgens DIN 44 991 (vlakdichtend) Lengte aansluitslang (bijgeleverd)	°C °dH kPa kPa kPa l/min inch/Zoll m	65 60 200 40 1.000 7,5 3/4" buitenschroefdr. ca. 1,7
	Waterafvoer	Afvoerslangen (diam.bi. x dikte) Lengte afvoerslang Lengte bij max. verlenging afvoerslang Opvoerhoogte afvoerpomp vanaf onderkant apparaat max. Volumestroom afvoer kortstondig max. Slangtuitje ter plaatse per afvoerslang (diam.bu. x l)	mm m m m l/min mm	22 x 6 ca. 1,5 ca. 4,0 1,0 16 22 x 30
	Dosering extern (optioneel)	Aansluiting voor max. twee doseerapparaten voor vloeibare reinigingsmiddelen en naspelmiddelen op de achterwand.		
	Machinevoet	In hoogte verstelbaar Diameter machinevoetjes Houder voor machinevoetjes	mm mm M	-0/+60 35 8

	Warmteafgifte aan de plaats van opstelling	Warmteafgifte (door straling) Warmteafgifte door spoelgoed bij leeghalen	kWh/h kWh/h	0,35 0,40
	Gegevens apparaat	Onderbouwhoogte Hoogte, incl. deksel (optie, ombouwset vereist) Breedte Diepte Deurhoogte Deurhoogte met deurbuitenplaat-compensatie (TAB) Nettogewicht Vloerbelasting als het apparaat in bedrijf is Machinebreedte, incl. transportpallet minimaal Machinediepte, incl. transportpallet min. Machinehoogte, incl. transportpallet minimaal	mm mm mm mm mm mm kg N mm mm mm	820 835 598 580 670 720 70 1.200 670 740 920
	Plaatsings-voorwaarden	Toegestane omgevingstemperatuur Max. rel. luchtvochtigheid Max. hoogte plaats van opstelling boven zeespiegel (NN) Zie gebruiksaanwijzing	°C % m	5-40 80 2.000
<p>De installatiewerkzaamheden mogen alleen door een erkend installateur worden uitgevoerd met inachtneming van alle van toepassing zijnde voorschriften en normen! Houdt u zich bij plaatsing van het apparaat beslist aan de gebruiksaanwijzing! Gebruik in de directe omgeving van de afwasautomaat alleen meubels/materialen die geschikt zijn voor professioneel gebruik, omdat anders schade kan optreden als gevolg van condens. Wijzigingen voorbehouden! Afmetingen tekeningen in mm.</p>				

Änderungsnr.	Datum	Bezeichnung:
A20370	10.04.2013	Einführung B0
A29196	01.10.2013	Überarbeitung SOP
A38134	09.06.2015	AC 230/50: 2,9 kW → 3,4 kW
A29163	08.12.2015	+ PT
A41972	08.02.2016	+ TR,

Legenda:







Skróty otoczone grubą linią oznaczają:
Przyłącze wymagane

PL



Skróty otoczone linią kropkową oznaczają:
Przyłącze opcjonalne lub wymagane w zależności od wykonania urządzenia

	Podłączenie elektryczne	1. Napięcie (stan fabryczny) Moc przyłączeniowa Zabezpieczenie Przewód podłączeniowy, przekrój minimalny Długość przewodu podłączeniowego (H05(07)RN-F) bez wtyczki		V/Hz kW A mm ² m	3N AC 400/50 8,9 3 × 16 5 × 2,5 ok. 1,7
		Napięcie Moc przyłączeniowa Zabezpieczenie Przewód podłączeniowy, przekrój minimalny Długość przewodu podłączeniowego (H05(07)RN-F) z wtyczką	przebudowlalne	V/Hz kW A mm ² m	AC 230/50 3,4 16 3 × 1,5 ok. 2,1
Różnice w następujących krajach:					
 		2. Napięcie (stan fabryczny) Moc przyłączeniowa Zabezpieczenie Przewód podłączeniowy, przekrój minimalny Długość przewodu podłączeniowego (H05(07)RN-F) bez wtyczki		V/Hz kW A mm ² m	3 AC 230/50 7,1 3 × 20 4 × 2,5 ok. 1,7
		Napięcie Moc przyłączeniowa Zabezpieczenie Przewód podłączeniowy, przekrój minimalny Długość przewodu podłączeniowego (H05(07)RN-F) z wtyczką	przebudowlalne	V/Hz kW A mm ² m	AC 230/50 3,4 16 3 × 1,5 ok. 2,1
		3. Napięcie (stan fabryczny) Moc przyłączeniowa Zabezpieczenie Przewód podłączeniowy, przekrój minimalny Długość przewodu podłączeniowego (H05(07)RN-F) bez wtyczki		V/Hz kW A mm ² m	3N AC 400/50 7,1 3 × 16 5 × 2,5 ok. 1,7
		Napięcie Moc przyłączeniowa Zabezpieczenie Przewód podłączeniowy, przekrój minimalny Długość przewodu podłączeniowego (H05(07)RN-F) z wtyczką	przebudowlalne	V/Hz kW A mm ² m	AC 230/50 3,4 16 3 × 1,5 ok. 2,1

		4. Napięcie (stan fabryczny) Moc przyłączeniowa Zabezpieczenie Przewód podłączeniowy, przekrój minimalny Długość przewodu podłączeniowego (H05(07)RN-F) bez wtyczki	przebudowlalne	V/Hz kW A mm ² m	3N AC 400/50 8,9 3 x 15-16 5 x 2,5 ok. 2,1
		Napięcie (stan fabryczny) Moc przyłączeniowa Zabezpieczenie Przewód podłączeniowy, przekrój minimalny Długość przewodu podłączeniowego (H05(07)RN-F) z wtyczką	przebudowlalne	V/Hz kW A mm ² m	AC 230/50 5,9 30-32 3 x 4 ok. 2,1
		Napięcie Moc przyłączeniowa Zabezpieczenie Przewód podłączeniowy, przekrój minimalny Długość przewodu podłączeniowego (H05(07)RN-F) z wtyczką	przebudowlalne	V/Hz kW A mm ² m	AC 230/50 3,4 13-16 3 x 1,5 ok. 2,1
		Zaleca się podłączenie urządzenia poprzez wtyczkę i gniazdo, żeby można było łatwo przeprowadzić kontrolę bezpieczeństwa elektrycznego. Wtyczka i gniazdo muszą być dostępne po instalacji urządzenia. W przypadku przyłącza stałego należy zainstalować wyłącznik główny z odłączeniem od sieci wszystkich biegunów i odstępem pomiędzy stykami o wielkości przynajmniej 3 mm. W celu podwyższenia bezpieczeństwa zdecydowanie zalecane jest poprzedzenie urządzenia wyłącznikiem różnicowoprądowym. Zgodnie z krajowymi przepisami instalacyjnymi należy ew. wykonać wyrównanie potencjału. Klasa ochronna IP21			
	Zimna woda	Temperatura maks. Maks. dopuszczalna twardość wody. Minimalne ciśnienie dynamiczne Minimalne ciśnienie dynamiczne przy przedłużeniu czasu pobierania wody Ciśnienie maksymalne Wielkość przepływu Gwint przyłącza po stronie instalacji wg DIN 44 991 (z uszczelnieniem płaskim) Długość węża przyłączeniowego (dostarczonego wraz z urządzeniem)		°C °dH kPa kPa kPa l/min cal m	20 60 200 40 1 000 7,5 3/4" gwint zewnętrzny ok. 1,7
	ciepła woda	Temperatura maks. Maks. dopuszczalna twardość wody. Minimalne ciśnienie dynamiczne Minimalne ciśnienie dynamiczne przy przedłużeniu czasu pobierania wody Ciśnienie maksymalne Wielkość przepływu Gwint przyłącza po stronie instalacji wg DIN 44 991 (z uszczelnieniem płaskim) Długość węża przyłączeniowego (dostarczonego wraz z urządzeniem)		°C °d kPa kPa kPa l/min cal m	65 60 200 40 1 000 7,5 3/4" gwint zewnętrzny ok. 1,7
	Odpyw	Wąż odpływowy (śr. x gr. ścianki) Długość węża odpływowego zmywarki profesjonalnej Maks. długość przedłużenia węża odpływowego Wysokość odpompowywania pompy spustowej od dolnej krawędzi urządzenia maks. Chwilowa wielkość odpływu maks. Tuleja instalacyjna węża, każdy wąż odpływowy (śr. zewn. x dł.)		mm m m m l/min mm	22 x 6 ok. 1.5 ok. 4,0 1,0 16 22 x 30
	Dozowanie zewn. (opcjonalnie)	Podłączenie do dwóch urządzeń dozujących dla detergentu w płynie i mediów splukujących z tyłu urządzenia.			

	Nóżki ustawcze	Regulowana wysokość Średnica nóżki ustawczej Gniazdo nóżki urządzenia	mm mm M	-0/+60 35 8
	Emisja ciepła do otoczenia	Emisja ciepła przez wypromieniowanie Emisja ciepła przez ładunek przy wyjmowaniu	kWh/h kWh/h	0,35 0,40
	Dane urządzenia	Wysokość zabudowy podblatowej Wysokość wraz z pokrywą (opcja, wymagany zestaw do przebudowy) Szerokość Głębokość Wysokość drzwiczek Wysokość drzwiczek z wyrównaniem zewnętrznej blachy drzwiczek (TAB) Waga netto Obciążenie podłoża w czasie pracy Szerokość załadunkowa wraz z paletą transportową, min. Głębokość załadunkowa wraz z paletą transportową, min. Wysokość załadunkowa wraz z paletą transportową, min.	mm mm mm mm mm mm kg N mm mm mm	820 835 598 580 670 720 70 1200 670 740 920
	Warunki ustawcze	Dopuszczalna temperatura otoczenia Względna wilgotność powietrza, maks. Wysokość ustawienia n.p.m., maks. Patrz wskazówki w instrukcji użytkowania	°C % m	5-40 80 2000
<p>Prace instalacyjne mogą być przeprowadzane wyłącznie przez koncesjonowanych instalatorów zgodnie z obowiązującymi przepisami, uwarunkowaniami urzędowymi, przepisami BHP i obowiązującymi normami! Przy ustawianiu urządzenia bezwzględnie przestrzegać instrukcji użytkowania! W otoczeniu zmywarki stosować wyłącznie meble/materiały przeznaczone do obszarów profesjonalnych, ponieważ w przeciwnym razie możliwe są uszkodzenia przez kondensat. Zmiany zastrzeżone! Wymiary na rysunkach w mm.</p>				

Nr wersji	Data	Opis:
A20370	10 04 2013	Wprowadzenie B0
A29196	01 10 2013	Opracowanie SOP
A38134	09.06.2015	AC 230/50: 2,9 kW → 3,4 kW
A29163	08.12.2015	+ PT
A41972	08.02.2016	+ TR,

Folha de dados técnicos

Miele
PROFESSIONAL

Máquina industrial de lavar louça

PG 8056

Legenda:







As abreviaturas no círculo em negrito significam:
Ligação necessária



As abreviaturas no círculo ponteados significam:
Ligação adequada ou necessária conforme o modelo

pt

EL	Ligação eléctrica	1. Tensão de alimentação (fornecido de fábrica) Potência nominal Fusíveis/disjuntor Cabo de ligação, secção mínima Comprimento cabo eléctrico (H05(07)RN-F) sem ficha		V/Hz kW A mm ² m	3N AC 400/50 8,9 3 × 16 5 × 2,5 aprox. 1,7
		Tensão de alimentação Potência nominal Fusíveis/disjuntor Cabo de ligação, secção mínima Comprimento cabo eléctrico (H05(07)RN-F) com ficha	comutável	V/Hz kW A mm ² m	AC 230/50 3,4 16 3 × 1,5 aprox. 2,1
Diferenças nos seguintes Países:					
B N		2. Tensão de alimentação (fornecido de fábrica) Potência nominal Fusíveis/disjuntor Cabo de ligação, secção mínima Comprimento cabo eléctrico (H05(07)RN-F) sem ficha		V/Hz kW A mm ² m	3 AC 230/50 7,1 3 × 20 4 × 2,5 aprox. 1,7
		Tensão de alimentação Potência nominal Fusíveis/disjuntor Cabo de ligação, secção mínima Comprimento cabo eléctrico (H05(07)RN-F) com ficha	comutável	V/Hz kW A mm ² m	AC 230/50 3,4 16 3 × 1,5 aprox. 2,1
I		3. Tensão de alimentação (fornecido de fábrica) Potência nominal Fusíveis/disjuntor Cabo de ligação, secção mínima Comprimento cabo eléctrico (H05(07)RN-F) sem ficha		V/Hz kW A mm ² m	3N AC 400/50 7,1 3 × 16 5 × 2,5 aprox. 1,7
		Tensão de alimentação Potência nominal Fusíveis/disjuntor Cabo de ligação, secção mínima Comprimento cabo eléctrico (H05(07)RN-F) com ficha	comutável	V/Hz kW A mm ² m	AC 230/50 3,4 16 3 × 1,5 aprox. 2,1

	4. Tensão de alimentação (fornecido de fábrica) Potência nominal Fusíveis/disjuntor Cabo de ligação, secção mínima Comprimento cabo eléctrico (H05(07)RN-F) sem ficha	comutável	V/Hz kW A mm ² m	3N AC 400/50 8,9 3 x 15-16 5 x 2,5 aprox. 2,1
	Tensão de alimentação (fornecido de fábrica) Potência nominal Fusíveis/disjuntor Cabo de ligação, secção mínima Comprimento cabo eléctrico (H05(07)RN-F) com ficha	comutável	V/Hz kW A mm ² m	AC 230/50 5,9 30-32 3 x 4 aprox. 2,1
	Tensão de alimentação Potência nominal Fusíveis/disjuntor Cabo de ligação, secção mínima Comprimento cabo eléctrico (H05(07)RN-F) com ficha	comutável	V/Hz kW A mm ² m	AC 230/50 3,4 13-16 3 x 1,5 aprox. 2,1
	<p>Recomendamos que a máquina seja ligada através de um dispositivo de encaixe para que fique facilitada qualquer intervenção técnica. A tomada/dispositivo de encaixe deve ter acesso fácil após a máquina estar instalada. Em caso de ligação fixa deve ser instalado um comutador principal, por conta do utilizador, com separação de todos os polos da rede e com uma abertura de contacto de pelo menos 3 mm. Para aumentar a segurança é aconselhado ligar a máquina a um disjuntor diferencial.</p> <p>De acordo com as normas vigentes também deve ser instalado um potencial de terra com bom contacto.</p> <p>Classe de protecção IP21</p>			
	Água fria	Temperatura máx. Grau de dureza da água máx. admissível Pressão mínima de fluxo Pressão mín. de fluxo no caso de prolongamento do tempo de entrada pressão máxima Caudal Rosca de ligação existente no local de acordo com DIN 44 991 (vedação plana) Comprimento da mangueira de ligação (Faz parte do fornecimento) Em ligações, só no Reino Unido, deve ser prevista uma válvula de segurança (válvula de retenção dupla).	°C °dH kPa kPa kPa l/min Polegada m	20 60 200 40 1.000 7,5 3/4" Rosca exterior aprox. 1,7
	Água quente	Temperatura máx. Grau de dureza da água máx. admissível Pressão mínima de fluxo Pressão mín. de fluxo no caso de prolongamento do tempo de entrada pressão máxima Caudal Rosca de ligação existente no local de acordo com DIN 44 991 (vedação plana) Comprimento da mangueira de ligação (Faz parte do fornecimento) Em ligações, só no Reino Unido, deve ser prevista uma válvula de segurança (válvula de retenção dupla).	°C °dH kPa kPa kPa l/min Polegada m	65 60 200 40 1.000 7,5 3/4" Rosca exterior aprox. 1,7
	Esgoto	Mangueiras de esgoto (di x s) Comprimento da mangueira de esgoto da máquina de lavar louça industrial Comprimento máx. prolongamento da mangueira de esgoto Altura de elevação bomba de esgoto a partir do canto inferior do aparelho máx. Caudal volúmico temporário máx. de esgoto Passador já existente no local para cada mangueira (da x l)	mm m m m l/min mm	22 x 6 aprox. 1.5 aprox. 4,0 1,0 16 22 x 30

	Dosagem externa (opção)	Ligação até dois doseadores para detergentes e abrillantador líquidos na zona posterior da máquina.		
	Pés	Altura regulável Diâmetro dos pés Espaço para os pés do aparelho	mm mm M	-0/+60 35 8
	Emissão de calor no local de instalação	Emissão de calor por radiação Emissão de calor pelos utensílios ao serem retirados	kWh/h kWh/h	0,35 0,40
	Características	Altura para encastrar Altura incl. tampo (Opção necessário conjunto conversão) Largura Profundidade Altura da porta Alt. da porta com chapa exterior de compensação (TAB) Peso líquido Carga exercida no solo em funcionamento Largura mínima incluindo palete de transporte Profundidade mínima incluindo palete de transporte Altura mínima incluindo palete de transporte	mm mm mm mm mm mm kg N mm mm mm	820 835 598 580 670 720 70 1.200 670 740 920
	Condições de instalação	Temperatura ambiente admissível Humidade relativa do ar máx. Instalação a uma altitude máx. acima do nível do mar consulte o livro de instruções	°C % m	5-40 80 2.000
<p>A instalação só deverá ser efectuada por pessoal especializado e de acordo com as normas de segurança e regulamentos de prevenção de acidentes em vigor. Para a instalação do aparelho, observe as instruções de utilização! Na área em volta da máquina de lavar louça apenas deve existir mobiliário/material adequado ao uso industrial para evitar o risco de danos provocado pela água e pela condensação. Dimensões em mm. Salvo alterações!</p>				

Nr. da alteração	Data	Designação
A20370	10-04-2013	Introdução B0
A29196	01-10-2013	Revisão SOP
A38134	09-06-2015	AC 230/50: 2,9 kW → 3,4 kW
A29163	08-12-2015	+ PT
A41972	08.02.2016	+ TR,

Teknik Veri Sayfası**Miele**
PROFESSIONAL





Sanayi tipi bulaşık makinesi

PG 8056

Açıklama:

Kalın daire içindeki kısaltmaların anlamı:
Bağlantı gereklidir**TR**Kesik çizgili daire içindeki kısaltmaların anlamı:
Bağlantı isteğe bağlıdır veya cihaz versiyonuna göre gereklidir

EL	Elektrik bağlantısı		V/Hz kW A mm ² m	3N AC 400/50 8,9 3 x 16 5 x 2,5 yakl. 1,7
	1 Gerilim (teslimat anındaki durum) Bağlantı değeri Koruma Bağlantı kablosu, asgari kesit Bağlantı kablosunun fişsiz uzunluğu (H05(07)RN-F)		V/Hz kW A mm ² m	3N AC 400/50 8,9 3 x 16 5 x 2,5 yakl. 1,7
	Gerilim Bağlantı değeri Koruma Bağlantı kablosu, asgari kesit Bağlantı kablosunun fişle birlikte uzunluğu (H05(07)RN-F)	değiştirilebilir	V/Hz kW A mm ² m	AC 230/50 3,4 16 3 x 1,5 yakl. 2,1
Değerlerin farklı olduğu ülkeler:				
	2 Gerilim (teslimat anındaki durum) Bağlantı değeri Koruma Bağlantı kablosu, asgari kesit Bağlantı kablosunun fişsiz uzunluğu (H05(07)RN-F)		V/Hz kW A mm ² m	3 AC 230/50 7,1 3 x 20 4 x 2,5 yakl. 1,7
	Gerilim Bağlantı değeri Koruma Bağlantı kablosu, asgari kesit Bağlantı kablosunun fişle birlikte uzunluğu (H05(07)RN-F)	değiştirilebilir	V/Hz kW A mm ² m	AC 230/50 3,4 16 3 x 1,5 yakl. 2,1
	3 Gerilim (teslimat anındaki durum) Bağlantı değeri Koruma Bağlantı kablosu, asgari kesit Bağlantı kablosunun fişsiz uzunluğu (H05(07)RN-F)		V/Hz kW A mm ² m	3N AC 400/50 7,1 3 x 16 5 x 2,5 yakl. 1,7
	Gerilim Bağlantı değeri Koruma Bağlantı kablosu, asgari kesit Bağlantı kablosunun fişle birlikte uzunluğu (H05(07)RN-F)	değiştirilebilir	V/Hz kW A mm ² m	AC 230/50 3,4 16 3 x 1,5 yakl. 2,1

	<p>4 Gerilim (teslimat anındaki durum) Bağlantı değeri Koruma Bağlantı kablosu, asgari kesit Bağlantı kablosunun fişsiz uzunluğu (H05(07)RN-F)</p>	değiştirilebilir	V/Hz kW A mm ² m	3N AC 400/50 8,9 3 x 15-16 5 x 2,5 yakl. 2,1
	<p>Gerilim (teslimat anındaki durum) Bağlantı değeri Koruma Bağlantı kablosu, asgari kesit Bağlantı kablosunun fişle birlikte uzunluğu (H05(07)RN-F)</p>	değiştirilebilir	V/Hz kW A mm ² m	AC 230/50 5,9 30-32 3 x 4 yakl. 2,1
	<p>Gerilim Bağlantı değeri Koruma Bağlantı kablosu, asgari kesit Bağlantı kablosunun fişle birlikte uzunluğu (H05(07)RN-F)</p>	değiştirilebilir	V/Hz kW A mm ² m	AC 230/50 3,4 13-16 3 x 1,5 yakl. 2,1
	<p>Elektrik güvenliği kontrolünün kolayca gerçekleştirilebilmesi için cihazın bir fiş priz bağlantısı üzerinden bağlanması tavsiye olunur. Fiş priz bağlantısına cihaz kurulduktan sonra erişim mümkün olmalıdır. Cihaz bağlantısının sürekli olması durumunda, cihazı şebekeden tamamen ayıran bir ana şalter ve en az 3 mm kontak aralığı öngörülmelidir. Güvenliğin artırılması için cihazdan önce bir kaçak akım rölesi bağlanması şiddetle tavsiye olunur. Ulusal kurulum şartlarına göre, gerekirse bir eşpotansiyel kuşaklama tesis edilmelidir. Koruma sınıfı IP21</p>			
	Soğuk su	<p>Azami sıcaklık İzin verilen azami su sertliği Asgari akış basıncı Su alma süresi uzadığında asgari akış basıncı azami basınç Hacimsel akış DIN 44 991'e göre yerinde bağlantı vidası (düz kapamalı) Bağlantı hortumu uzunluğu (tedarik kapsamında)</p> <p>Sadece GB'de, bağlantı sırasında bir emniyet armatürü (double check valve) öngörülmelidir.</p>	°C °dH kPa kPa kPa l/dk İnç m	20 60 200 40 1.000 7,5 3/4" dış vida yakl. 1,7
	Sıcak su	<p>Maks. sıcaklık İzin verilen azami su sertliği Asgari akış basıncı Su alma süresi uzadığında asgari akış basıncı azami basınç Hacimsel akış DIN 44 991'e göre yerinde bağlantı vidası (düz kapamalı) Bağlantı hortumu uzunluğu (tedarik kapsamında)</p> <p>Sadece GB'de, bağlantı sırasında bir emniyet armatürü (double check valve) öngörülmelidir.</p>	°C °dH kPa kPa kPa l/dk İnç m	65 60 200 40 1.000 7,5 3/4" dış vida yakl. 1,7
	Atık Su	<p>Tahliye hortumları (di x s) Sanayi tipi bulaşık makinesi tahliye hortumu uzunluğu Tahliye hortumu azami Uzatma miktarı Tahliye pompasının cihazın tabanından azami basma yüksekliği Azami kısa süreli hacimsel tahliye akışı Tahliye hortumu için yerinde hortum rakoru (da x l)</p>	mm m m m l/dk mm	22 x 6 yakl. 1,5 yakl. 4,0 1,0 16 22 x 30
	Harici dozlama (isteğe bağlı)	Sıvı deterjan ve parlatici için makinenin arkasında en fazla iki dozaj ünitesi bağlantısı.		
	Ayak	<p>Yüksekliği ayarlanabilir Ayak çapı Cihaz ayakları için montaj yuvası</p>	mm mm M	-0/+60 35 8

	Kurulum mekanına ısı yayılımı	Isı ışıınımı yoluyla ısı yayılımı Boşaltma sırasında bulaşıklardan ısı yayılımı	kWh/h kWh/h	0,35 0,40
	Makine verileri	Tezgah altı yüksekliği Kapak dahil Yükseklik (Opsiyonel, dönüştürme kiti gerekli) Genişlik Derinlik Kapı yüksekliği Kapı dış panel ara parçası ile birlikte (TAB) kapı yüksekliği Net ağırlık İşletim sırasında zemin yükü Nakliye paleti dahil asgari yerleştirme genişliği Nakliye paleti dahil asgari yerleştirme derinliği Nakliye paleti dahil asgari yerleştirme yüksekliği	mm mm mm mm mm mm kg N mm mm mm	820 835 598 580 670 720 70 1.200 670 740 920
	Kurulum şartları	İzin verilen ortam sıcaklığı azami Bağıl Nem Deniz seviyesinden azami kurulum yüksekliği kullanma talimatlarındaki notlara bakınız	°C % m	5-40 80 2.000
<p>Kurulum sadece sertifikalı tesisatçılar tarafından ilgili geçerli yönetmeliklere, yasal esaslara, kaza önleme yönetmeliklerine ve geçerli standartlara göre gerçekleştirilmelidir! Cihaz kurulumu sırasında kullanım talimatına mutlaka uyulmalıdır! Bulaşık makinesinin çevresindeki alanda sadece endüstriyel alanda kullanıma uygun mobilya/ materyal yerleştirilmelidir, aksi takdirde yoğunlaşma sonucu hasar meydana gelebilir. Değişiklik yapma hakkı saklıdır! Çizim ölçüleri mm cinsinden</p>				

Değişiklik no.	Tarih	Adı:
A20370	10.04.2013	B0 uygulaması
A29196	01.10.2013	SOP revizyonu
A38134	09.06.2015	AC 230/50: 2,9 kW → 3,4 kW
A37239	15.06.2015	+ et-EE / lv-LV / lt-LT
A29163	09.12.2015	+ PT
A41972	08.02.2016	+ TR,

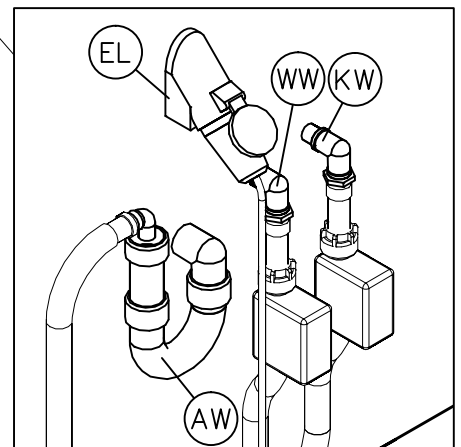
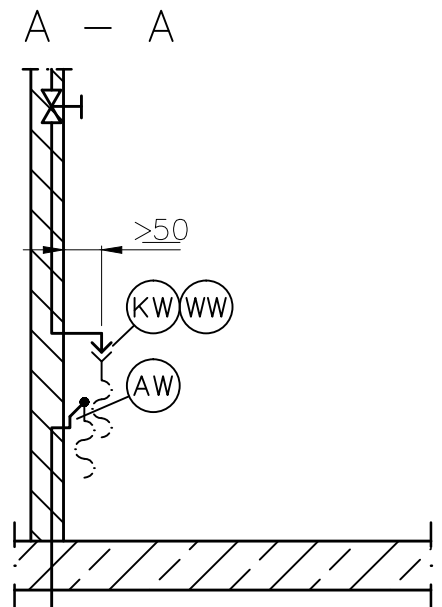
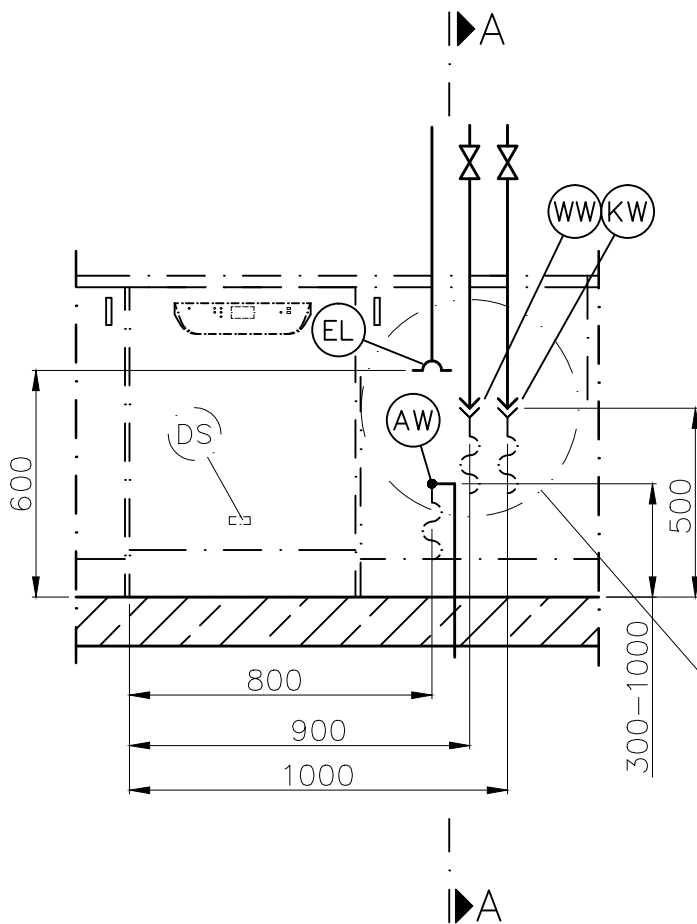
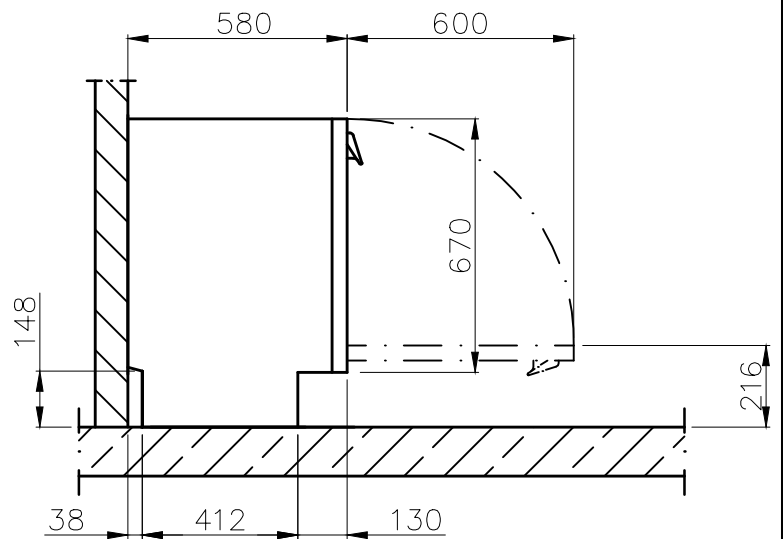
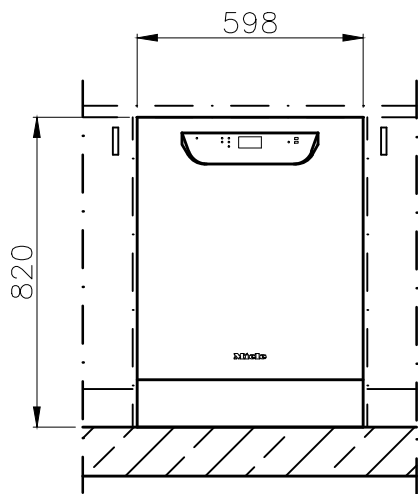

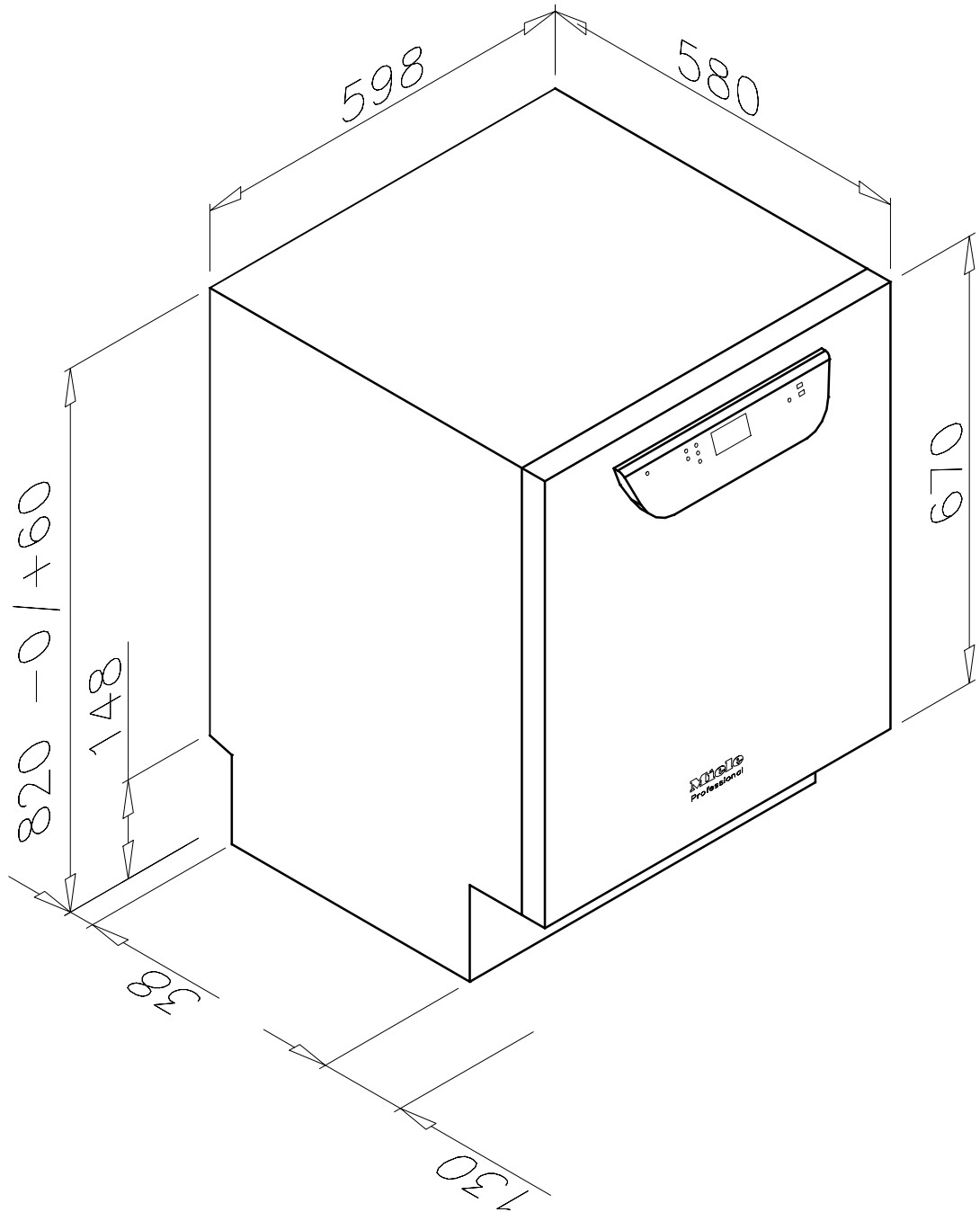

Miele
PROFESSIONAL

Installationsplan/Installation plan
Gewerbegeschirrspüler
PG 8056

Date:	01.10.2013
Page:	2/2
Name:	Gö